

1"

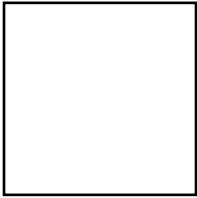

1"

SYMBOLS

V single notch

W double notch

I button hole

- 1/2" seam allowance included, but not shown
- follow grainline and fold line instructions on pattern pieces

CUT LINES FOR SIZES

Men's XS

Men's S

Men's M

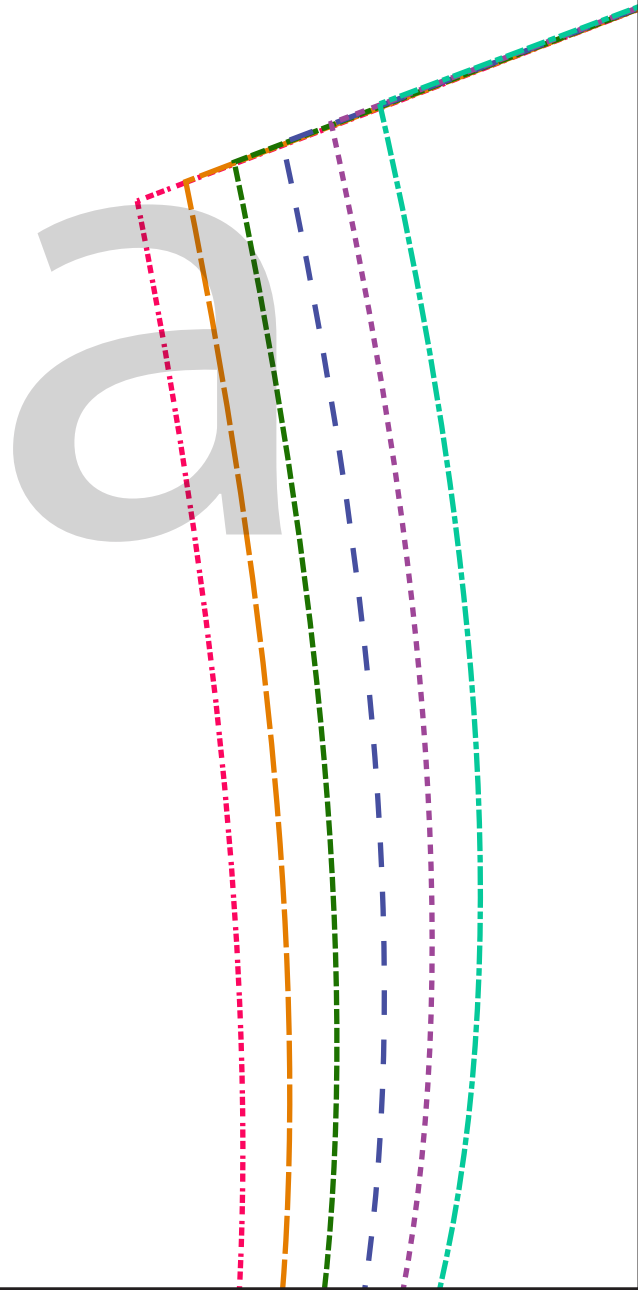

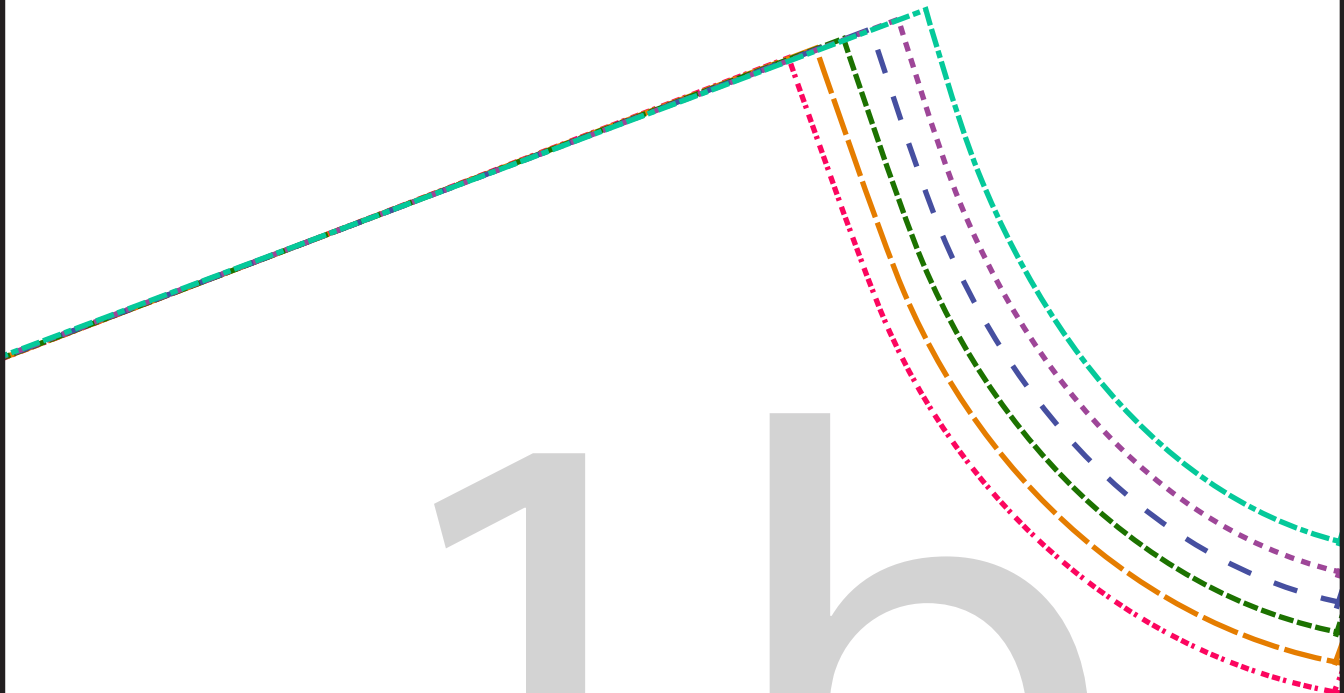

1b
A

X2
MENS Chore Jacket
Front Body
Self Fabric

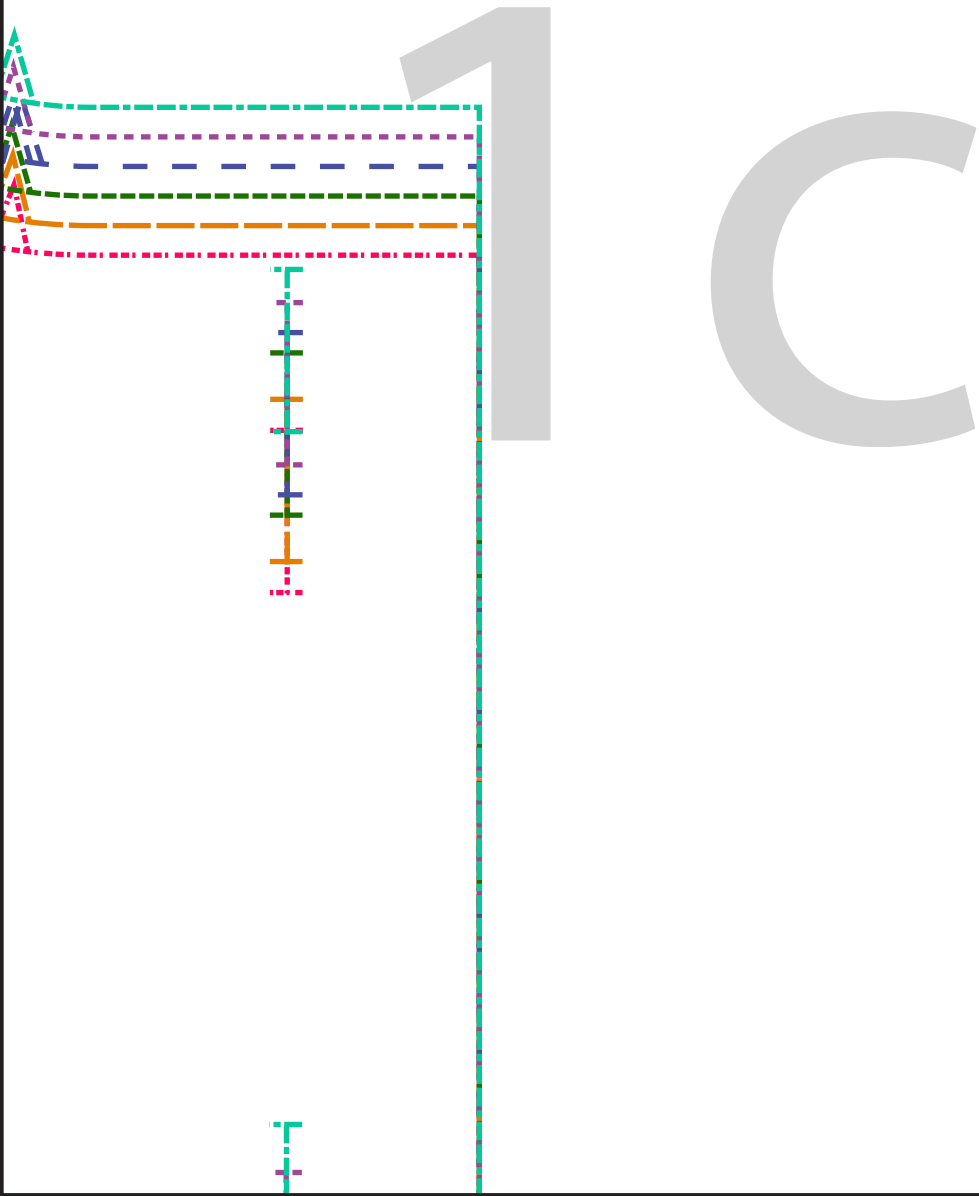



10 F

X1

MENS Chore Jacket
Back Yoke
self fabric

CLOTHWORKS

collective

- Men's L
- Men's XL
- Men's XXL

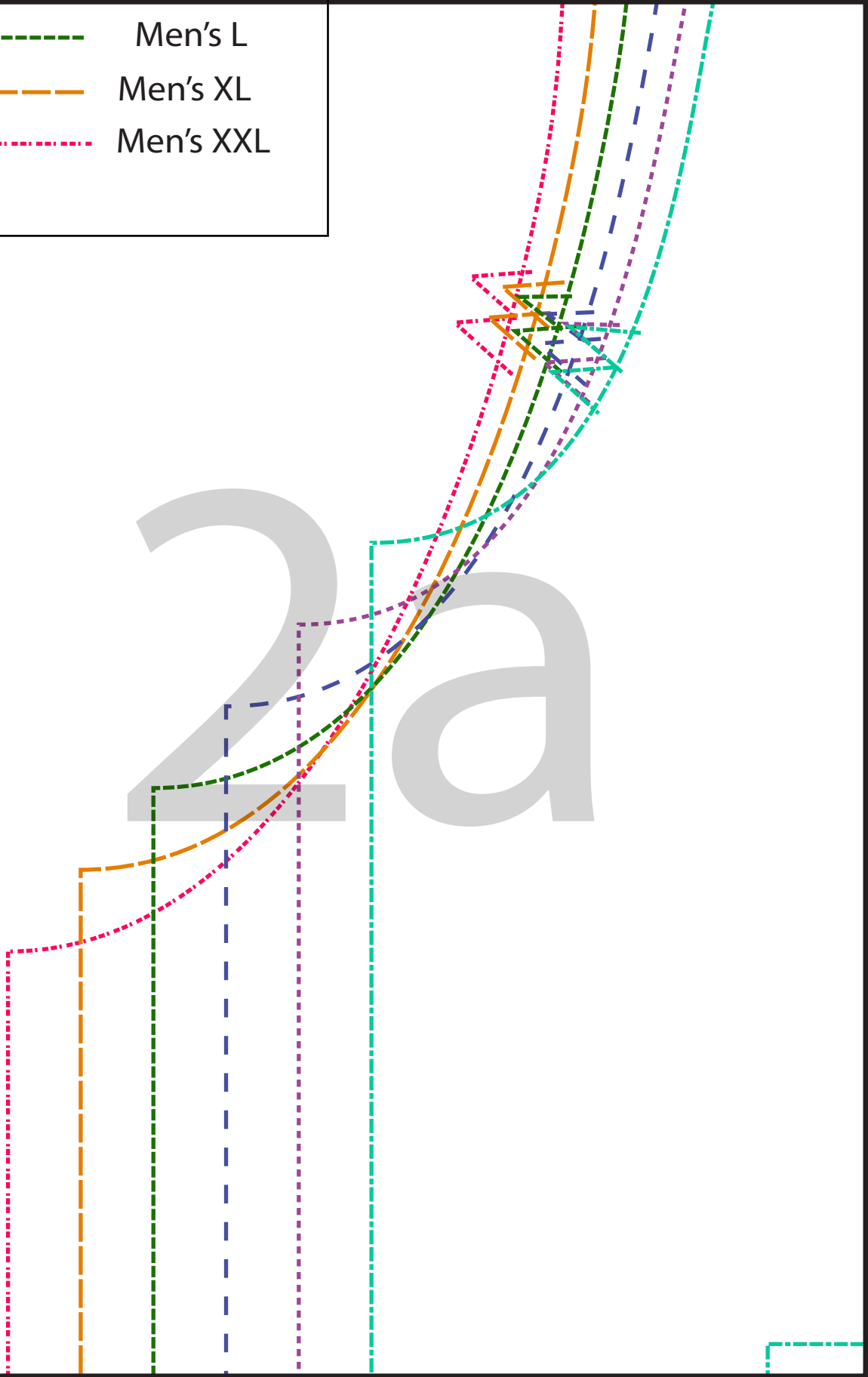

2b

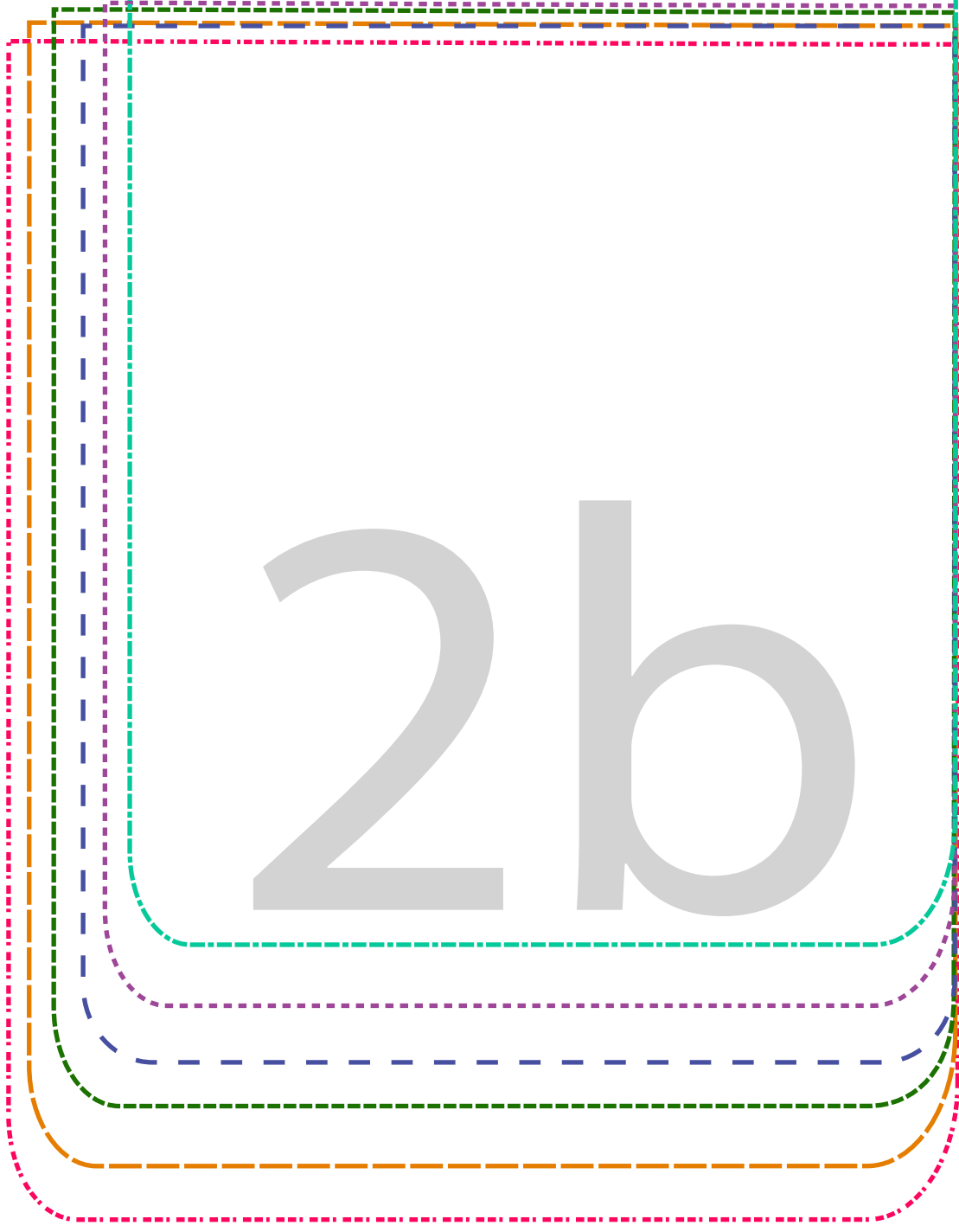

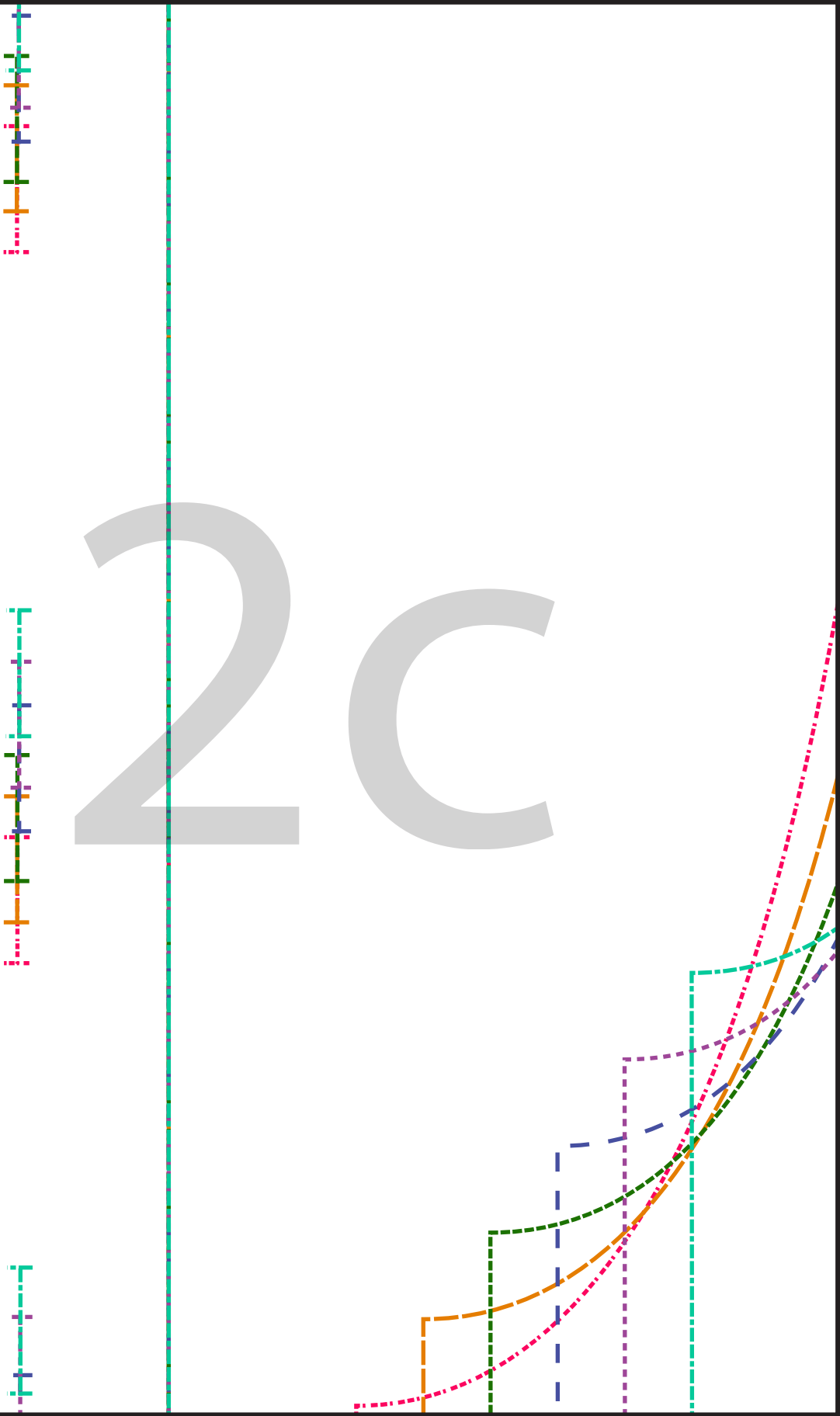



2d

B

X1

MENS Chore Jac

B L B L

3 a

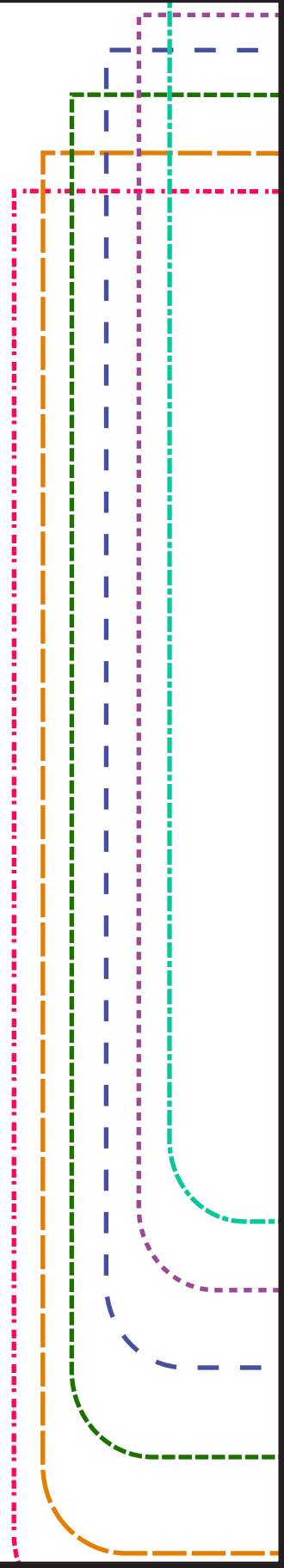

3b





3

z



3d

CLOTHWORKS

collective

4a

4b



Grainline

D

X2
MENS Chor
Top Po
Self Fa

4c

e Jacket
cket
oric

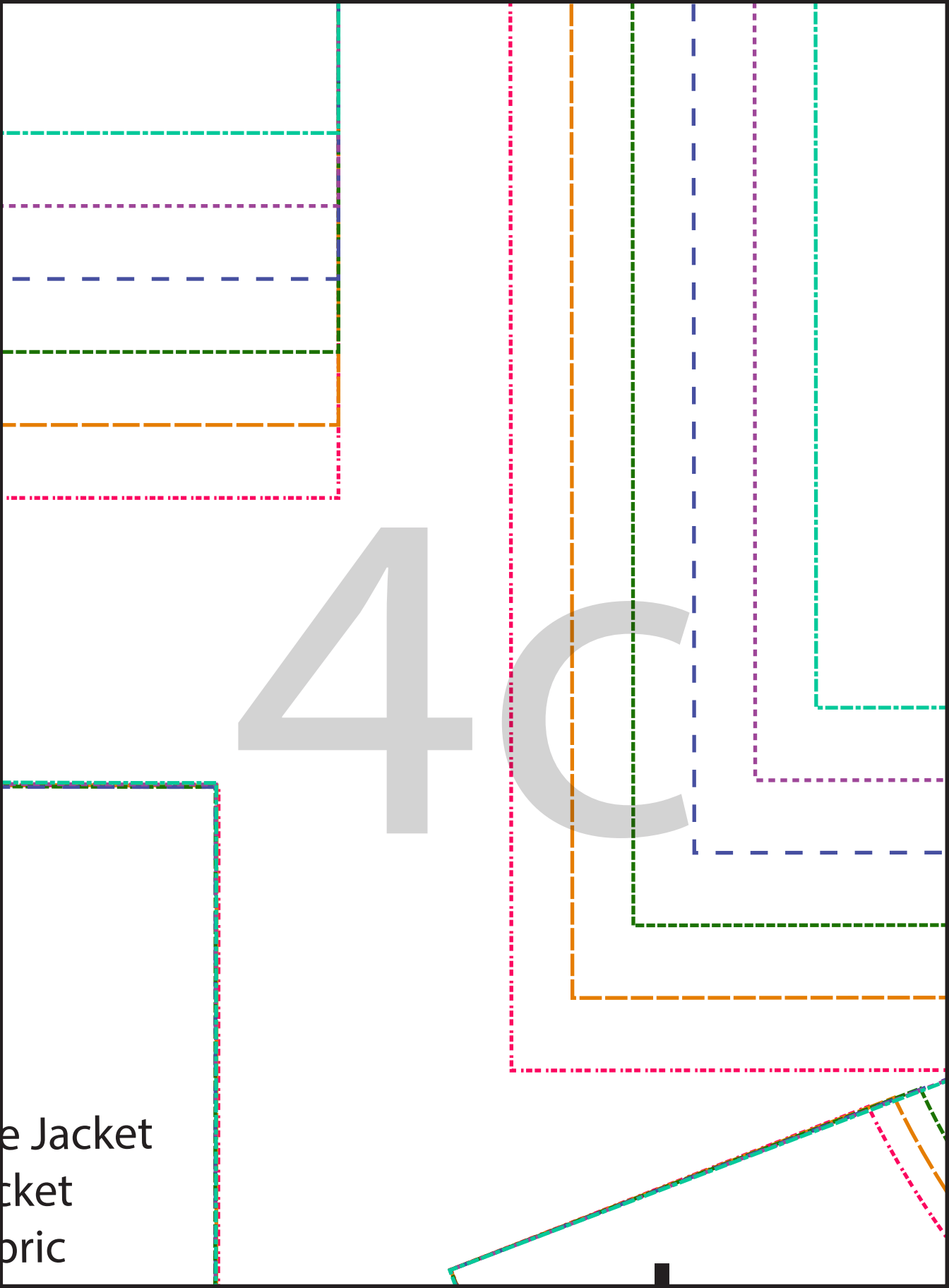

4d

CLOTHWORKS

collective

M

X2

MENS Chore Jacket
Bottom Pocket
Self Fabric

Grainline



CLOTHWORKS
collective

5a

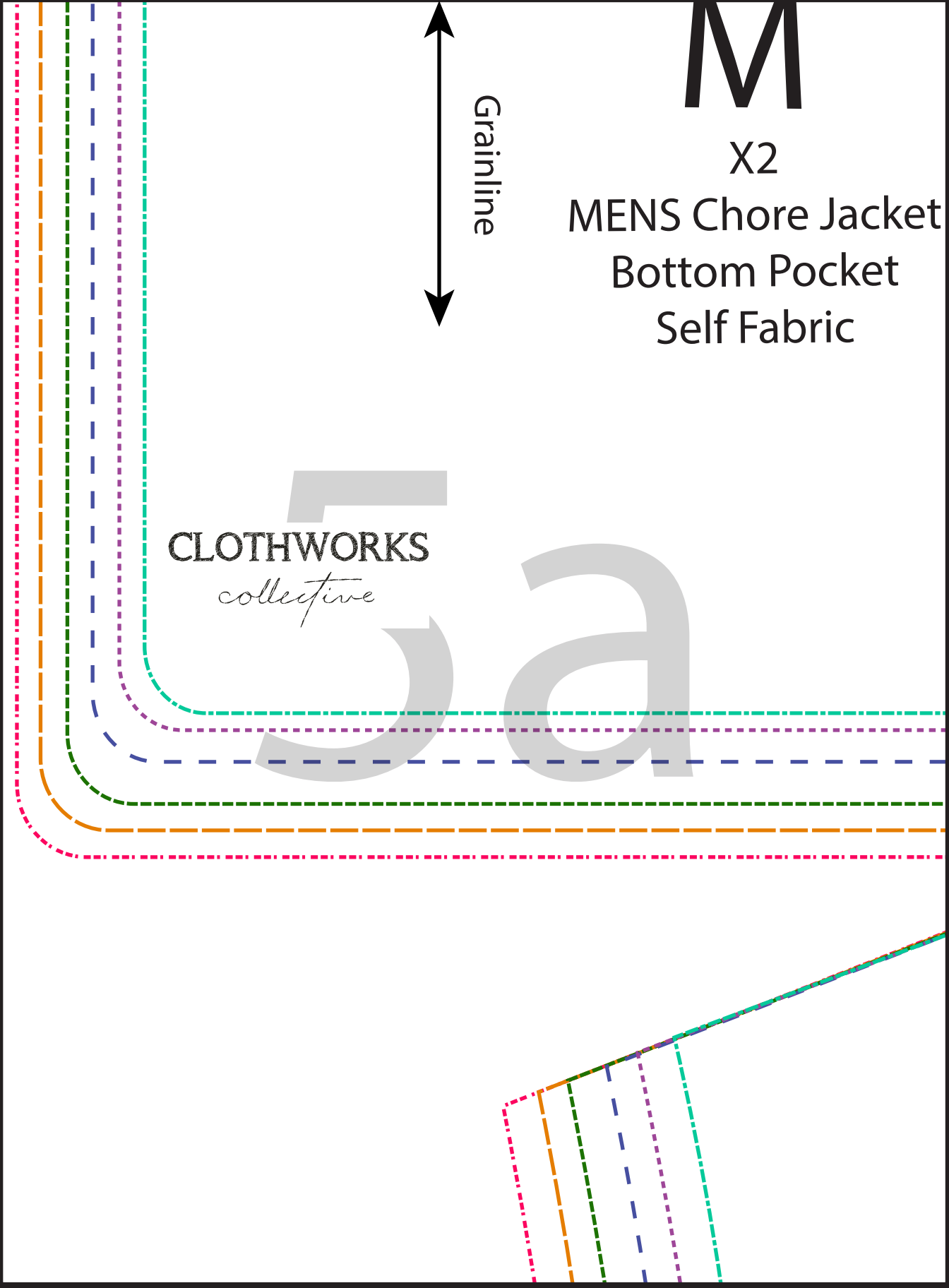



CLOTHWORKS
collective

510

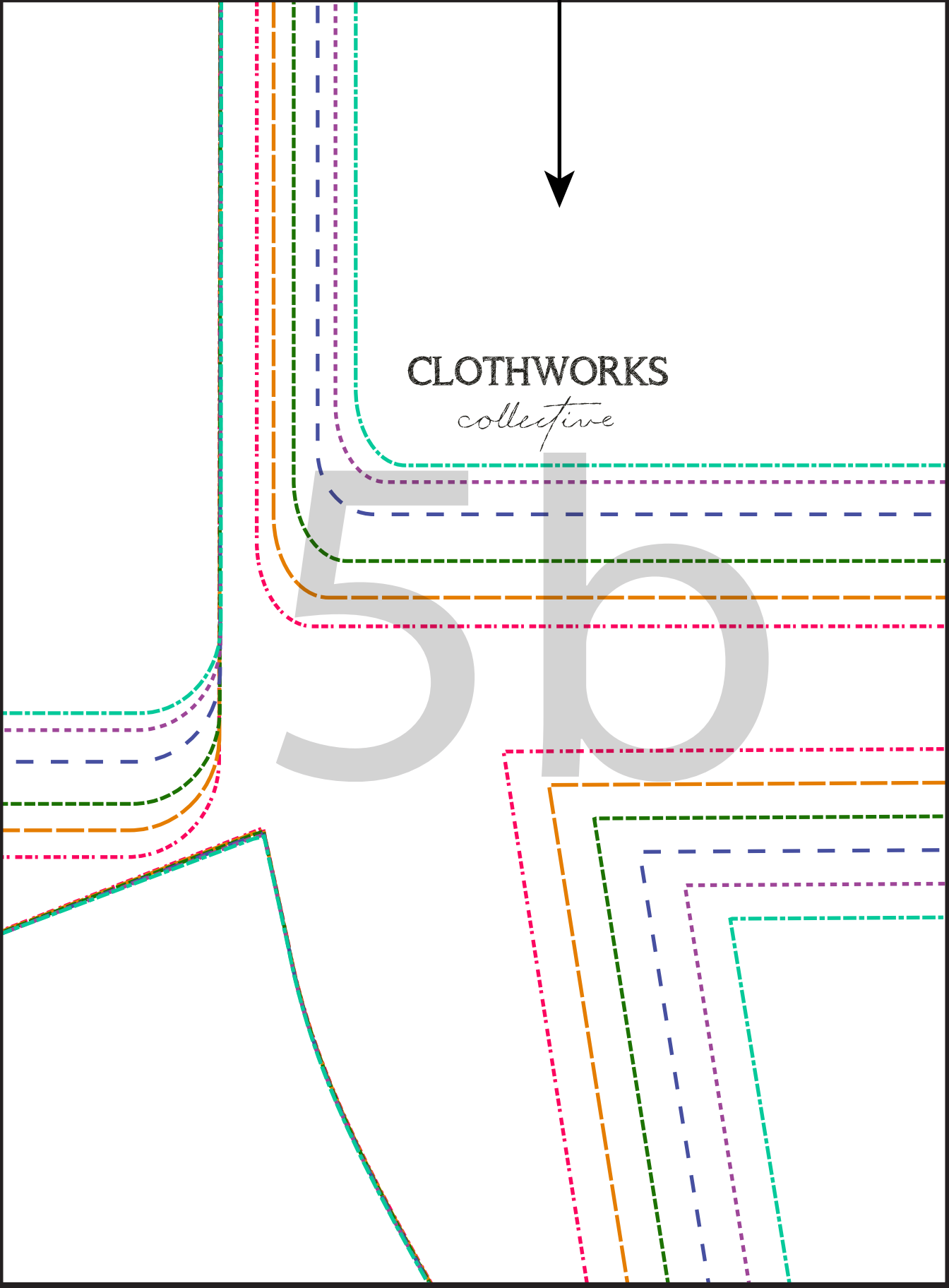

X1

MENS Chore
Back Faci
SELF FABR

5C

CLOTHWORKS
collective

Grainline

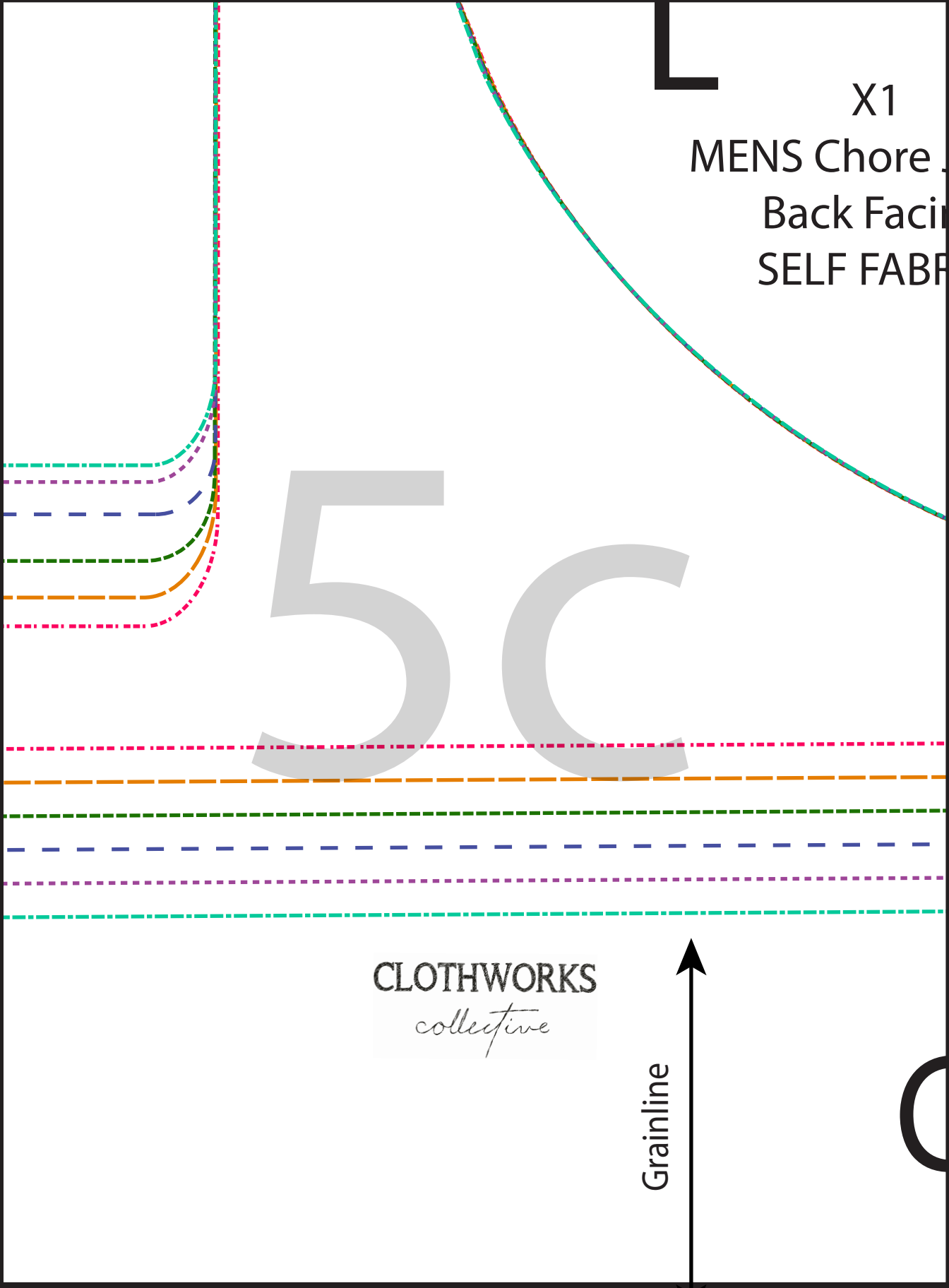

Jacket

ng
RIC

X1

Back Facing
INTERFACING

on fold



5d

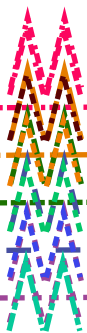

X1

MENS Chore Jacket
Top Collar
CONTRAST FABRIC

1/4" seam allowance
collar stand edge

6a

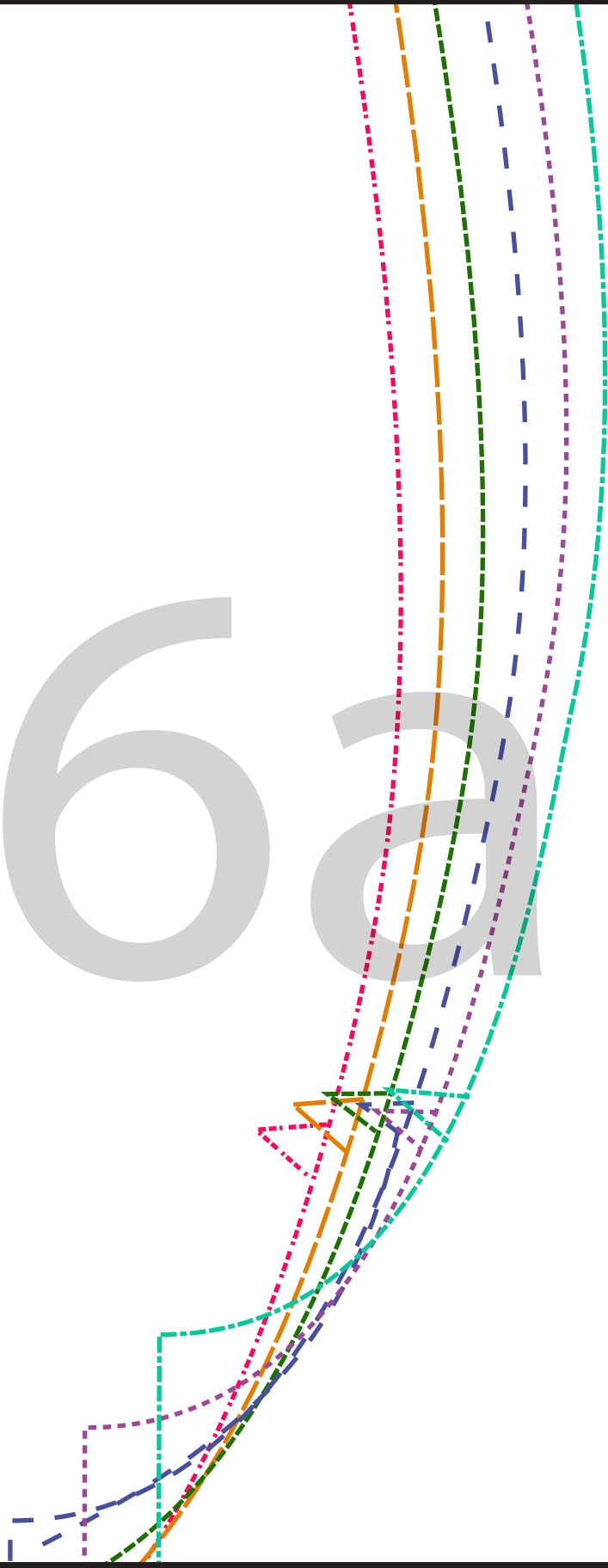

N

X2

MENS Chore Jacket

Font Lining

Lining Fabric

6b

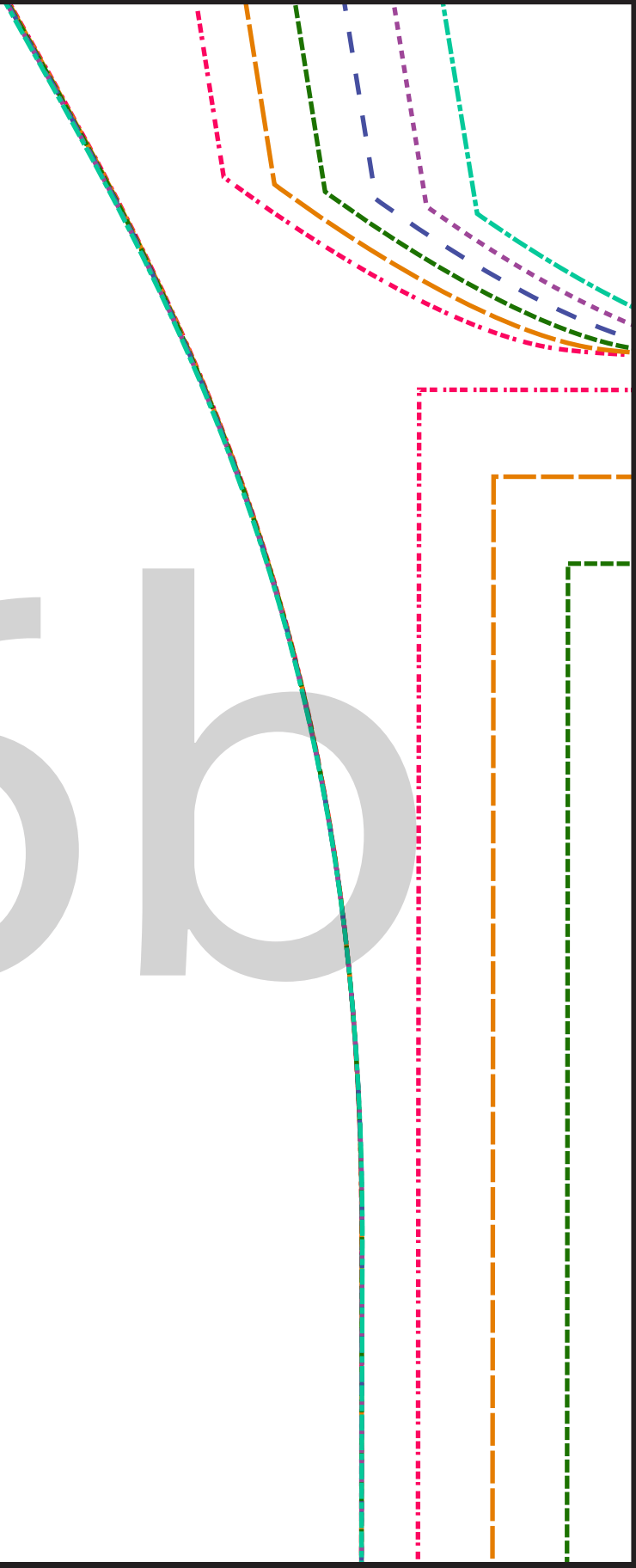

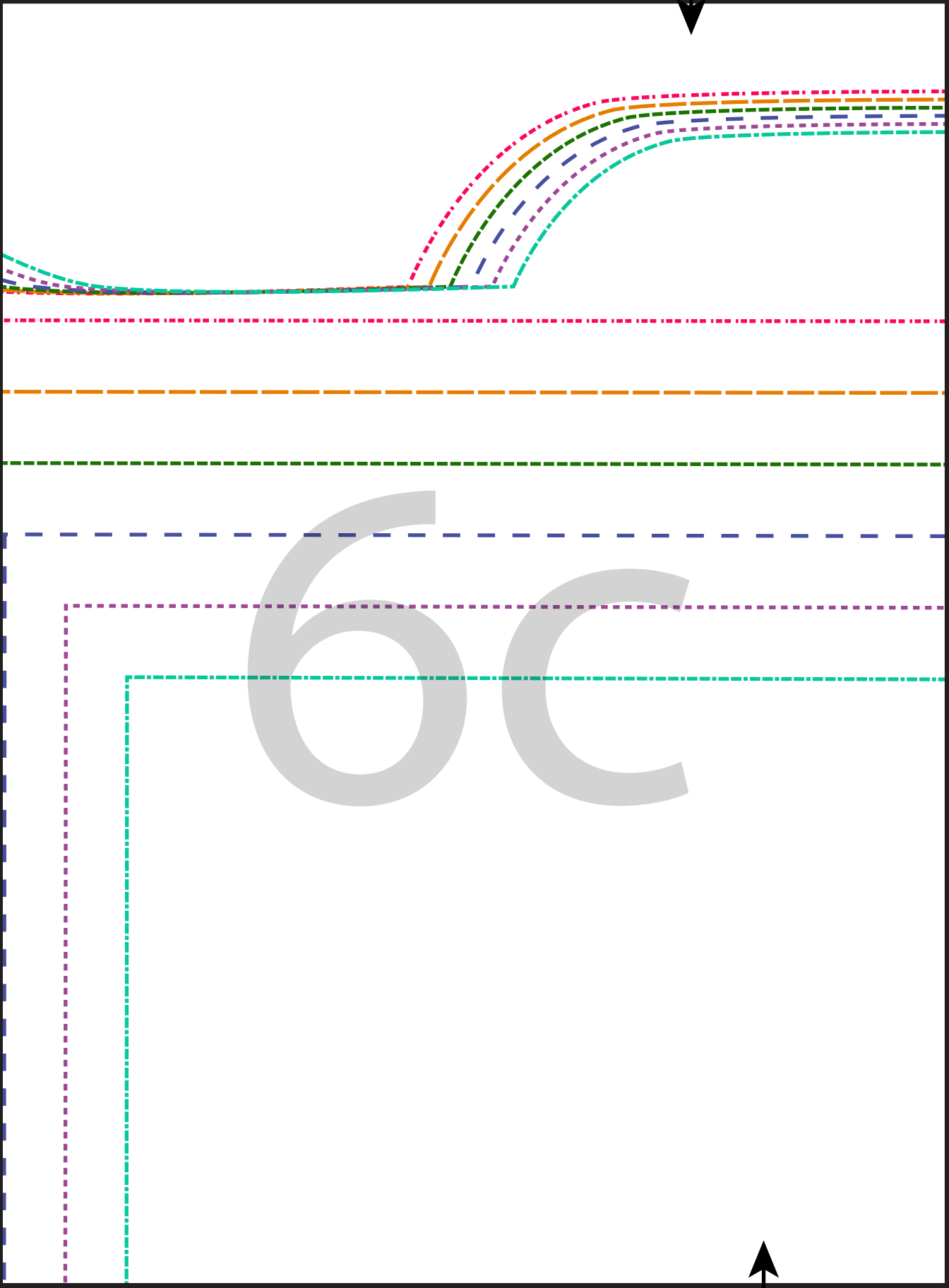

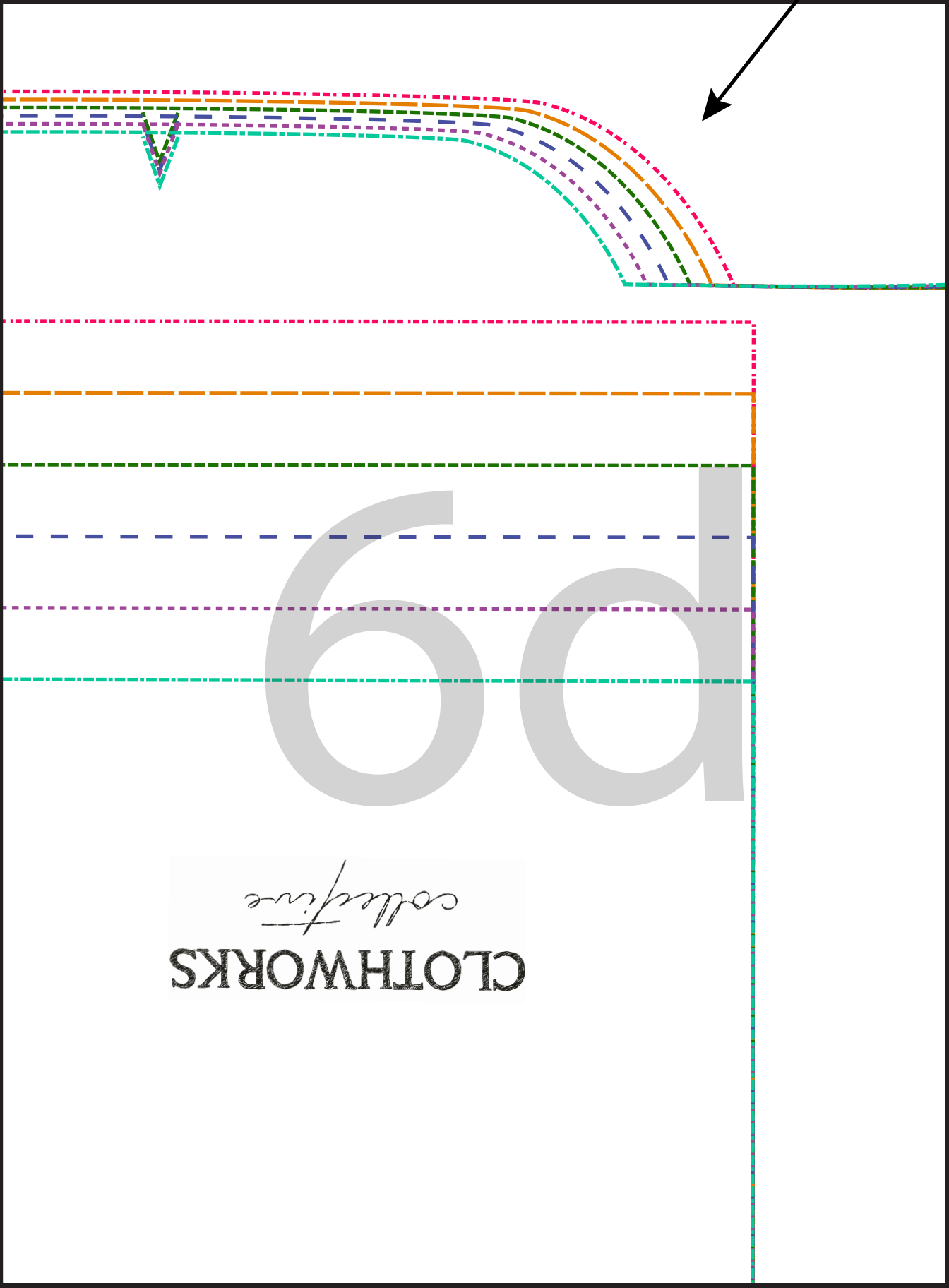

CLOTHWORKS
collective

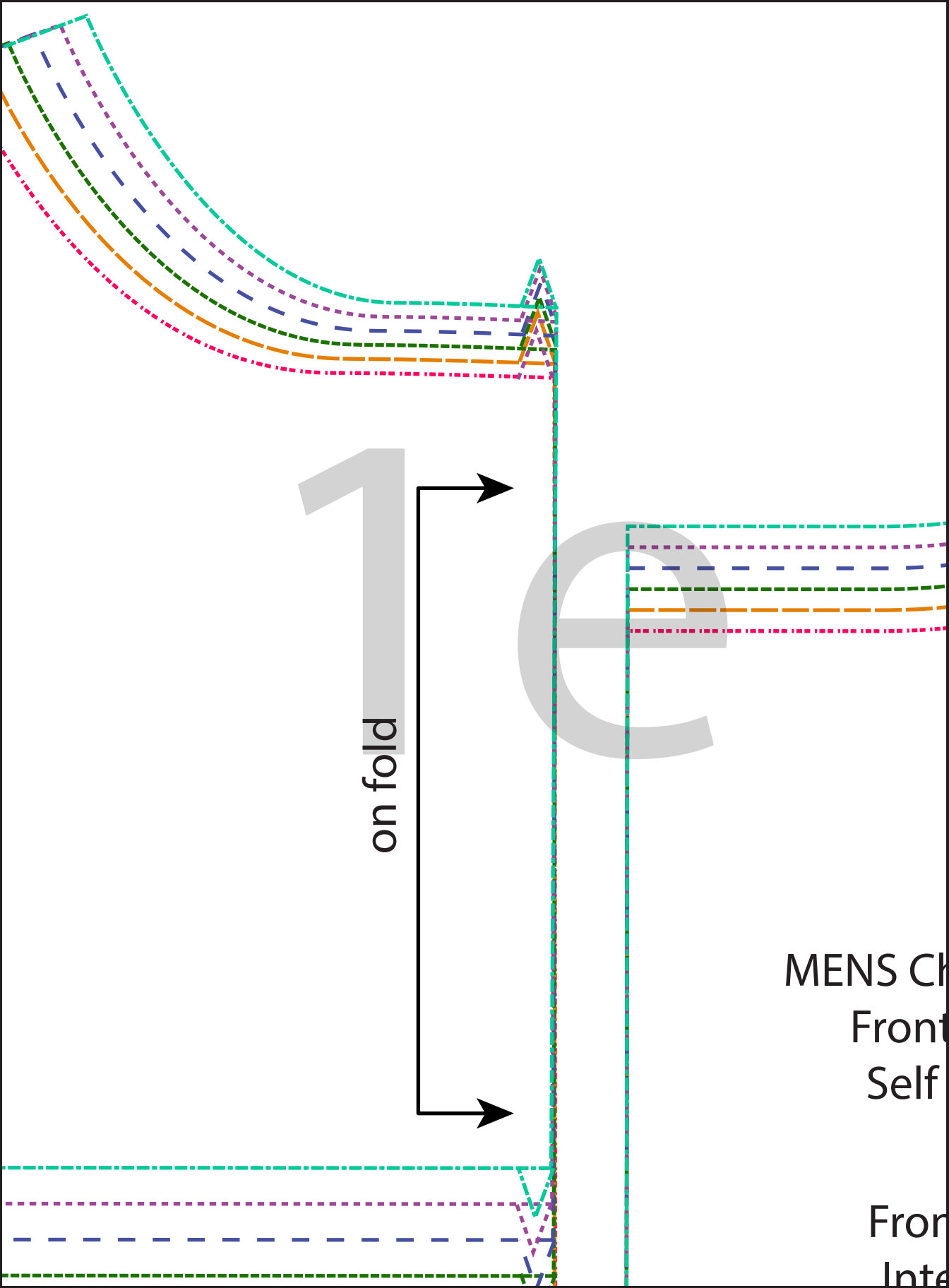

on fold

MENS CK

Front

Self

Front

Inte

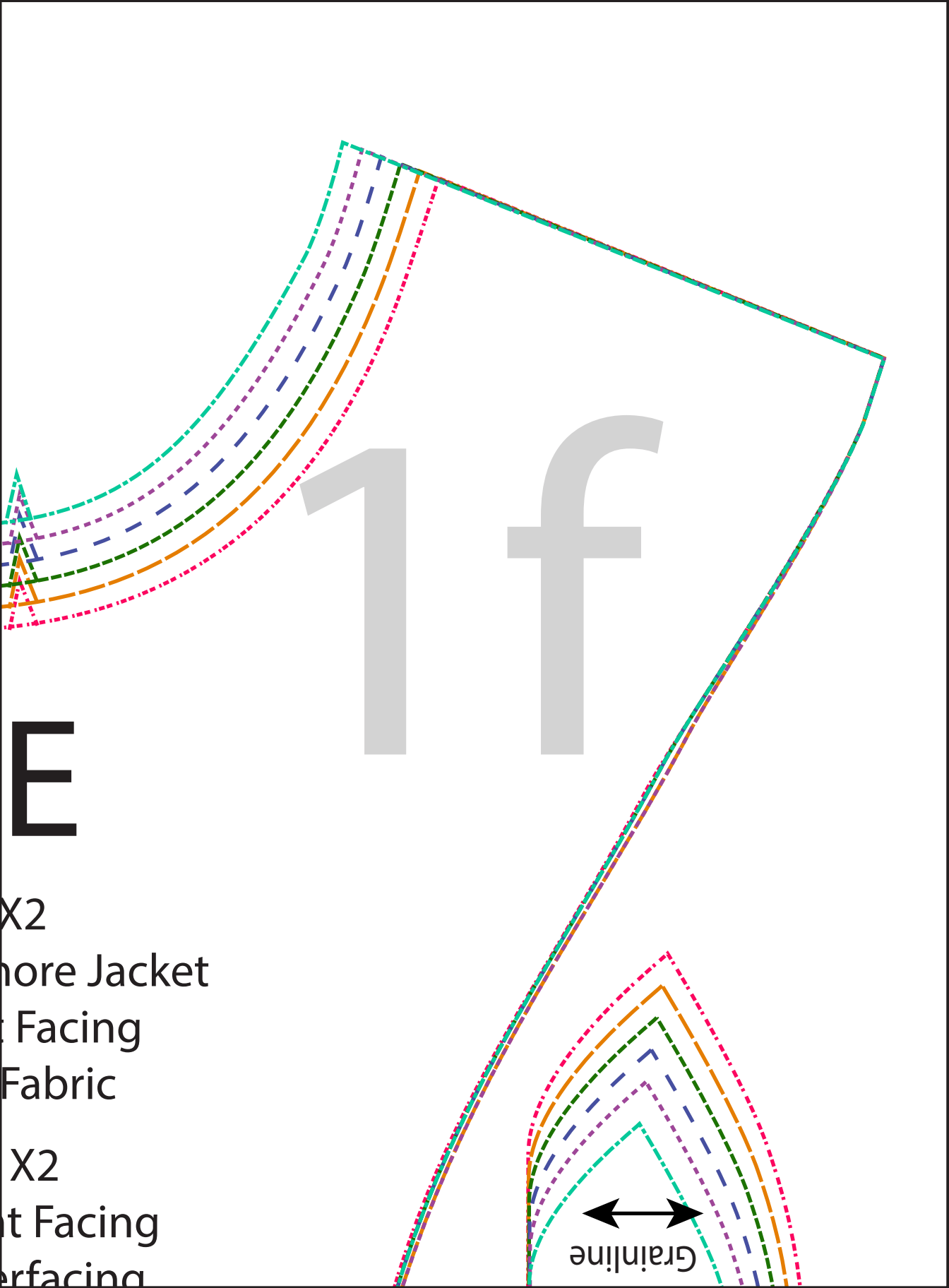

1f

E

X2
more Jacket
Facing
Fabric
X2
Facing
Facing

Grainline

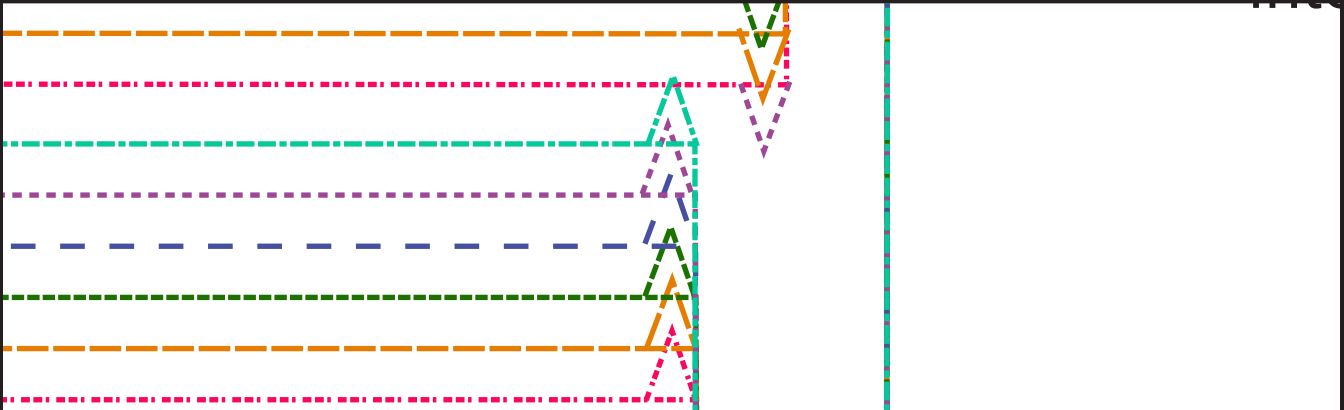

ze

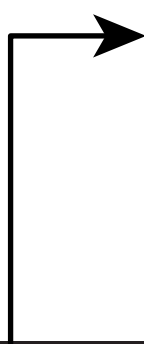

ket

Grainline

2

K

MENS Chore Jacket
Under Collar Stand

X1 SELF FABRIC X2 INTERFACING

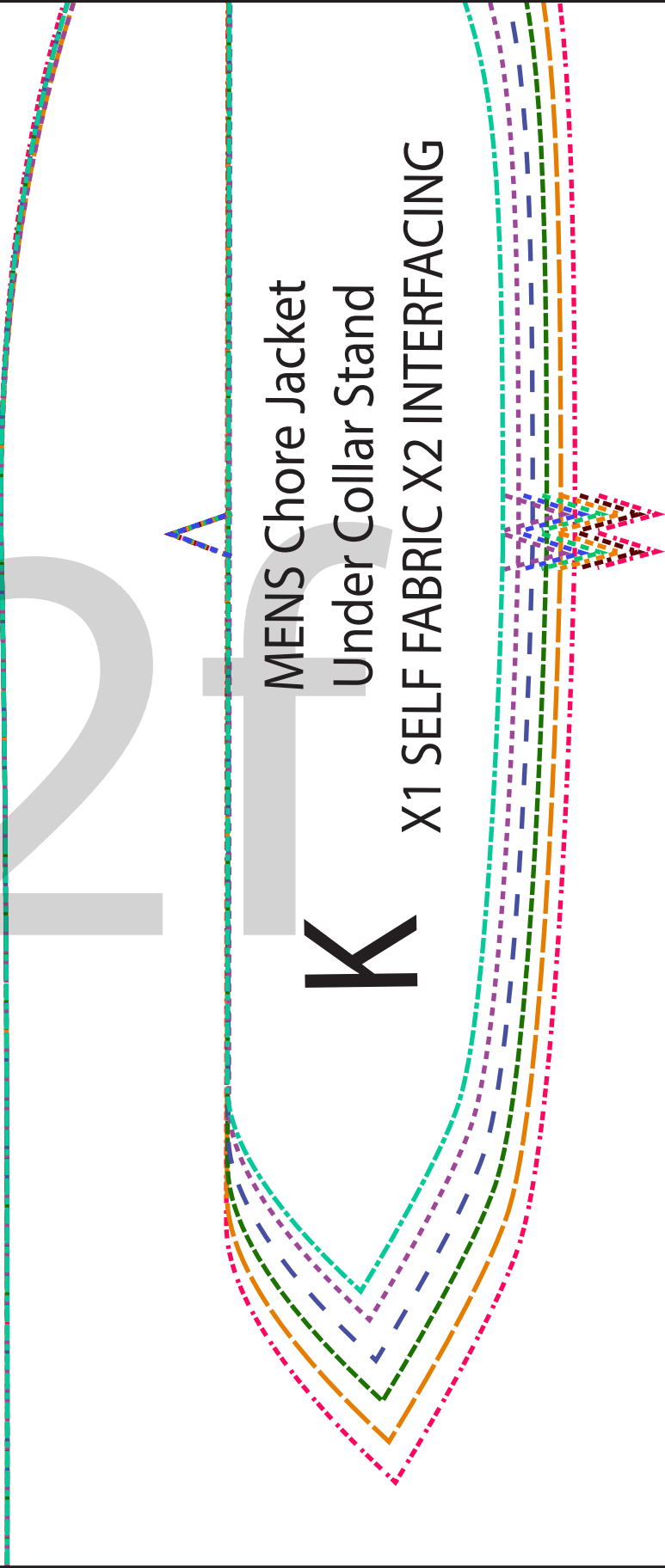

on fold
See



X1

Chore Jacket

MENS Tot Collar Stand

CONTRAST FABRIC

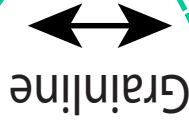

Grainline

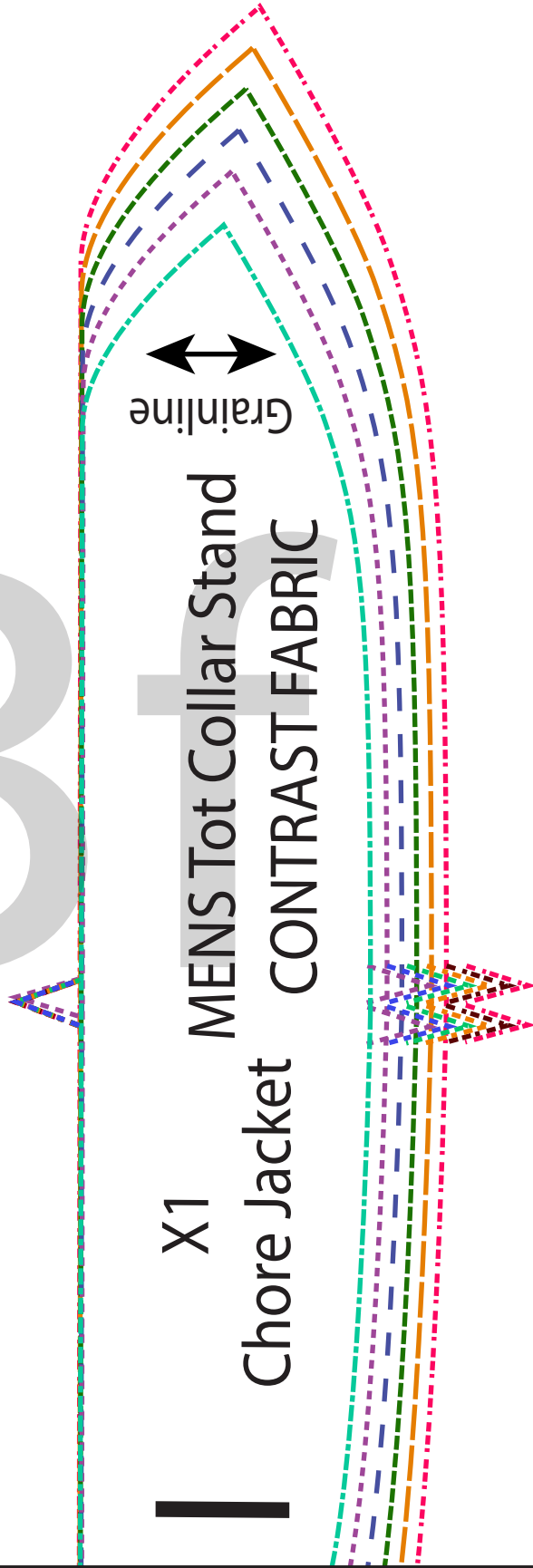

colleg

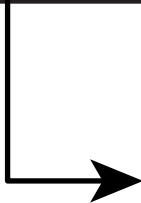

4 e

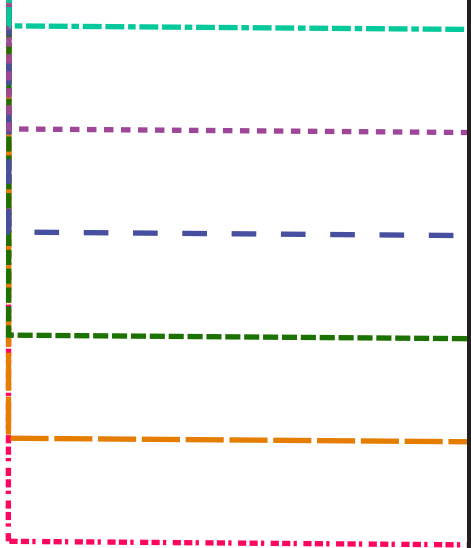
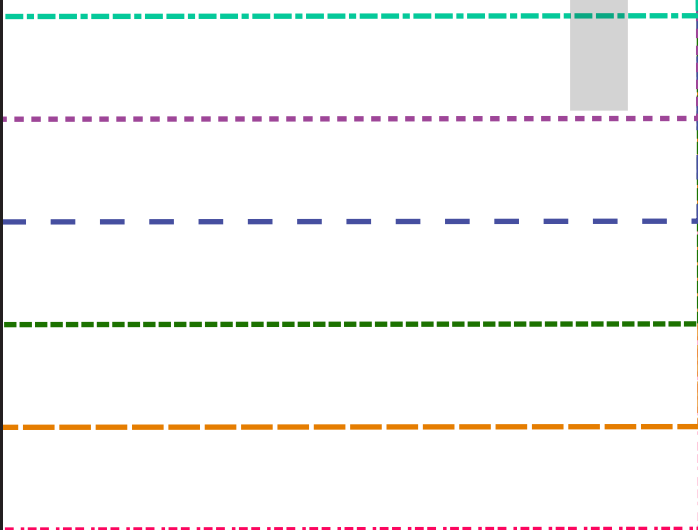

tive

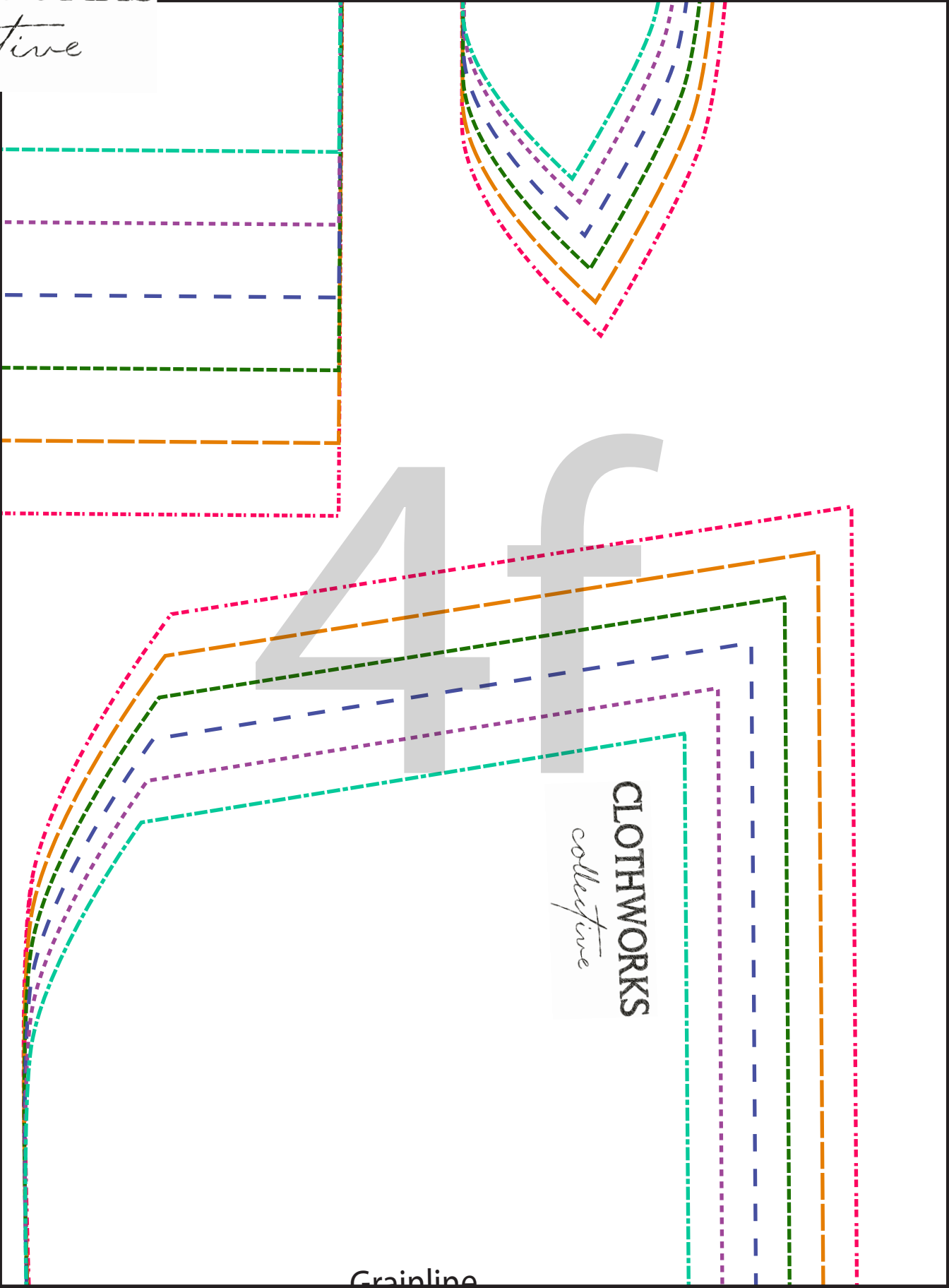

4f

CLOTHWORKS
collective

Grainline

X2
MENS Chore Jacket
Pocket Flap for
WEARER'S RIGHT SIDE
Self Fabric



along
e

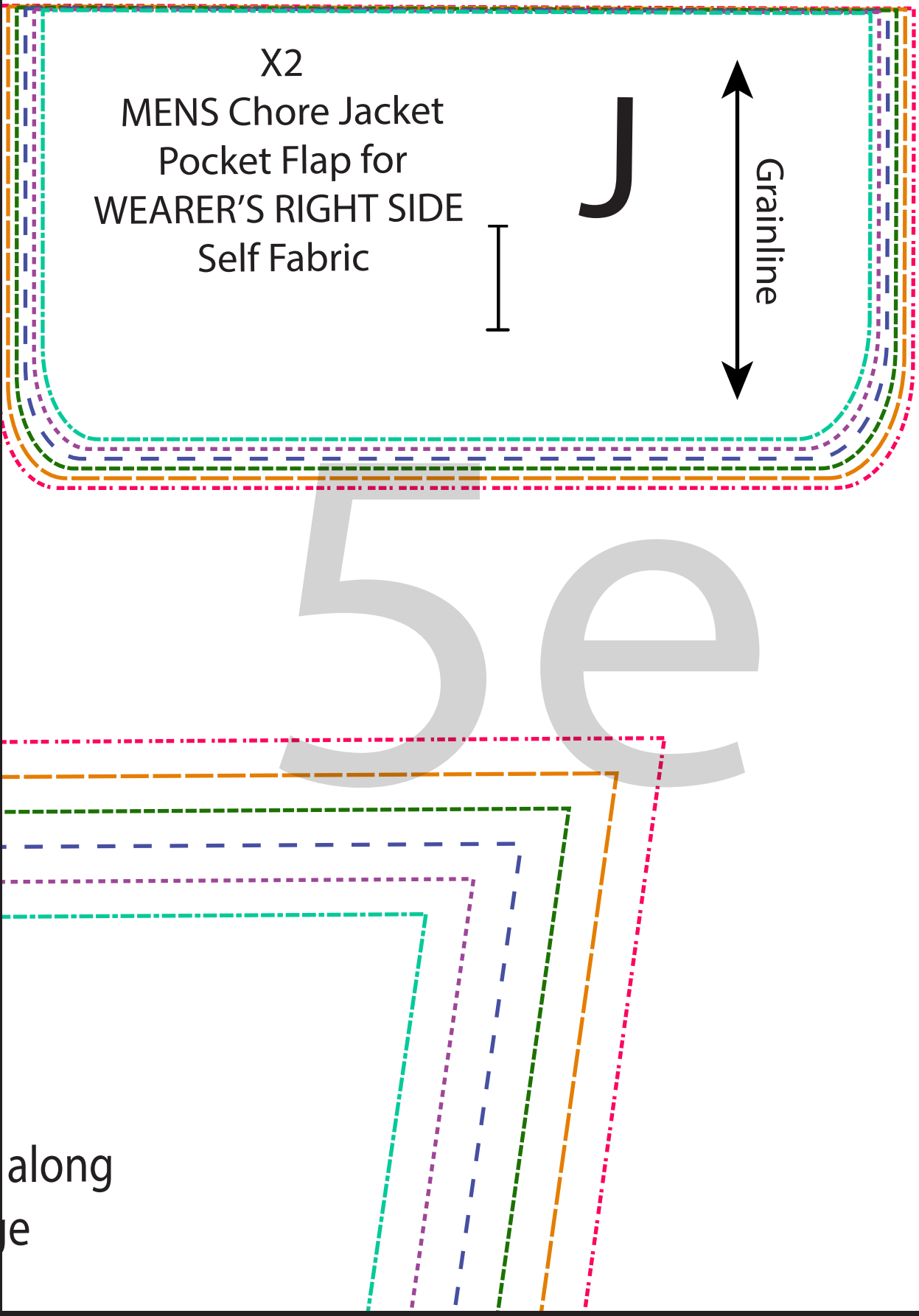

Grainline



H

MENS = Chore Jacket

Under Collar

5

X1 SELF FABRIC

X2 INTERFACING

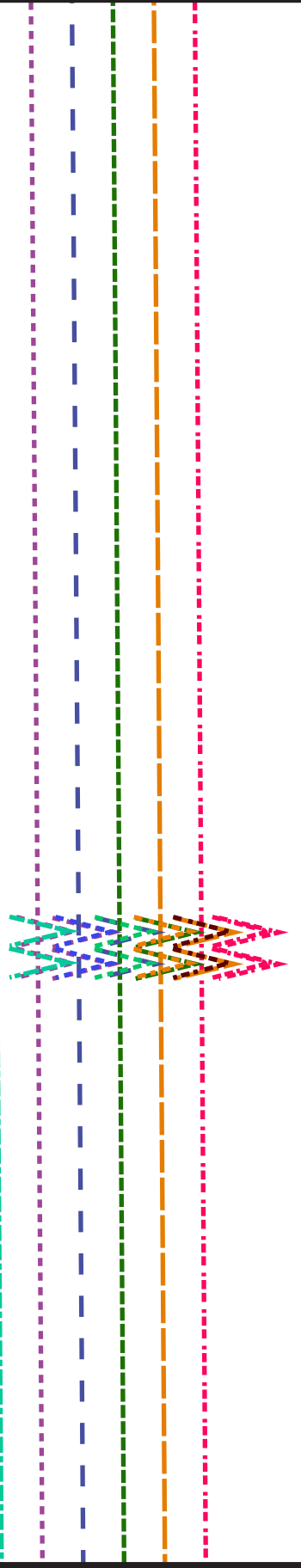

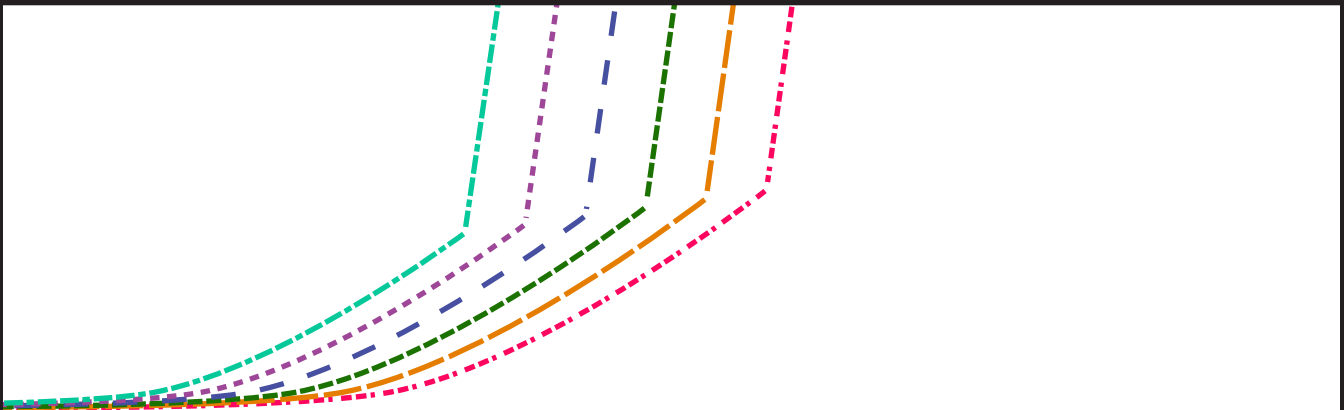

6e



1/4" seam allowance along
collar stand

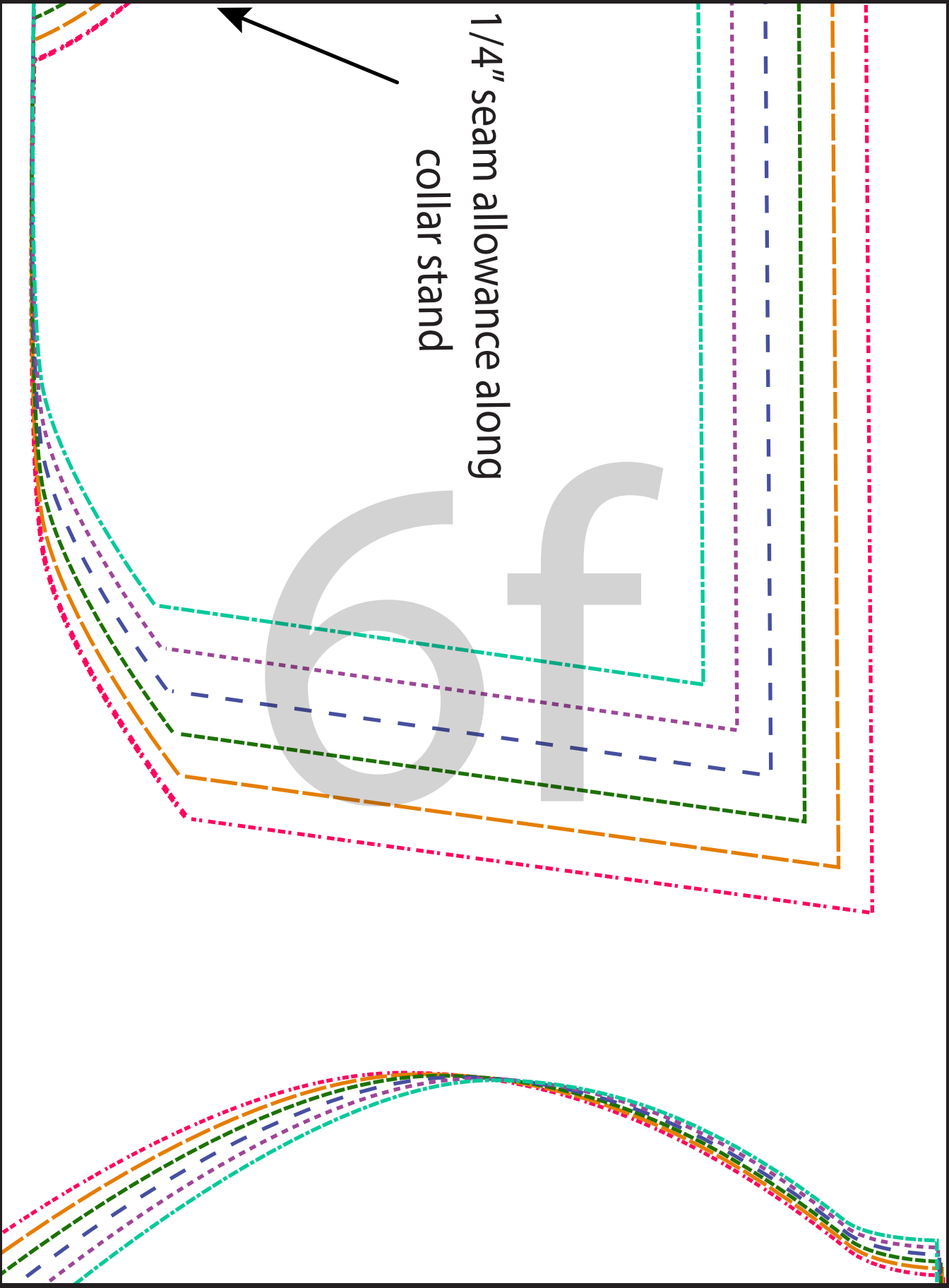

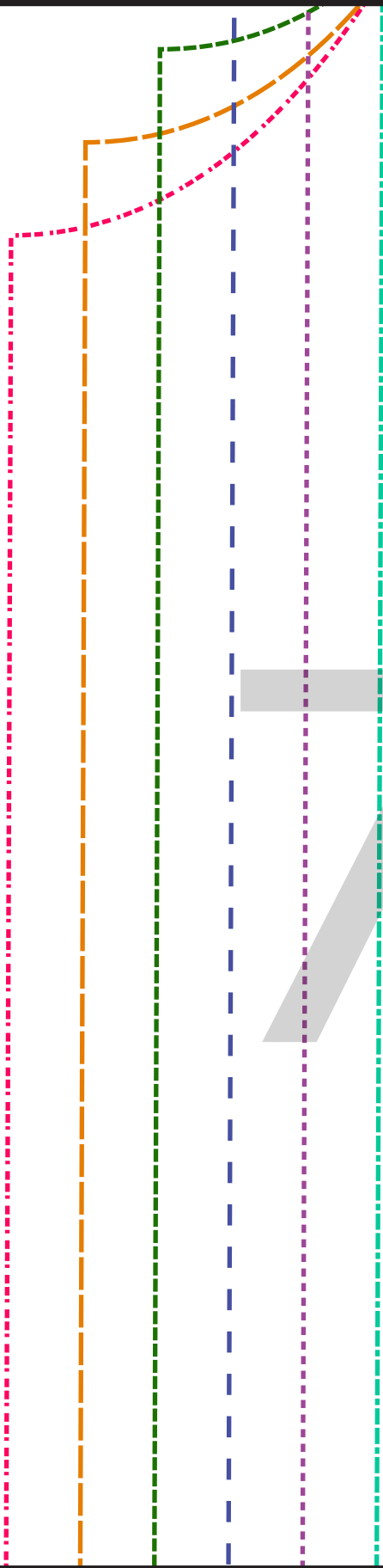

7

a

7b

Grainline

7c

Grainline

7d

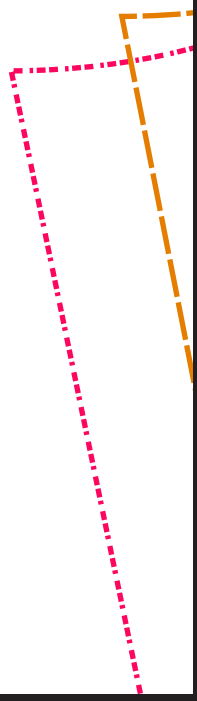

CLOTHWORKS

collective

8a



8b

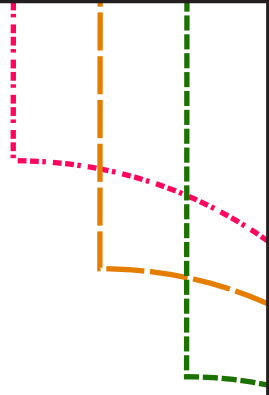
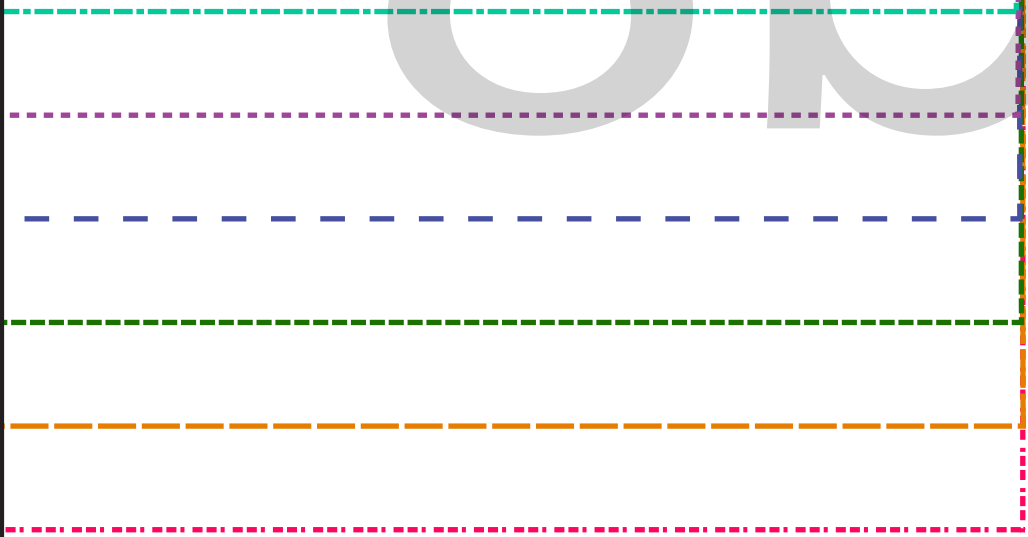

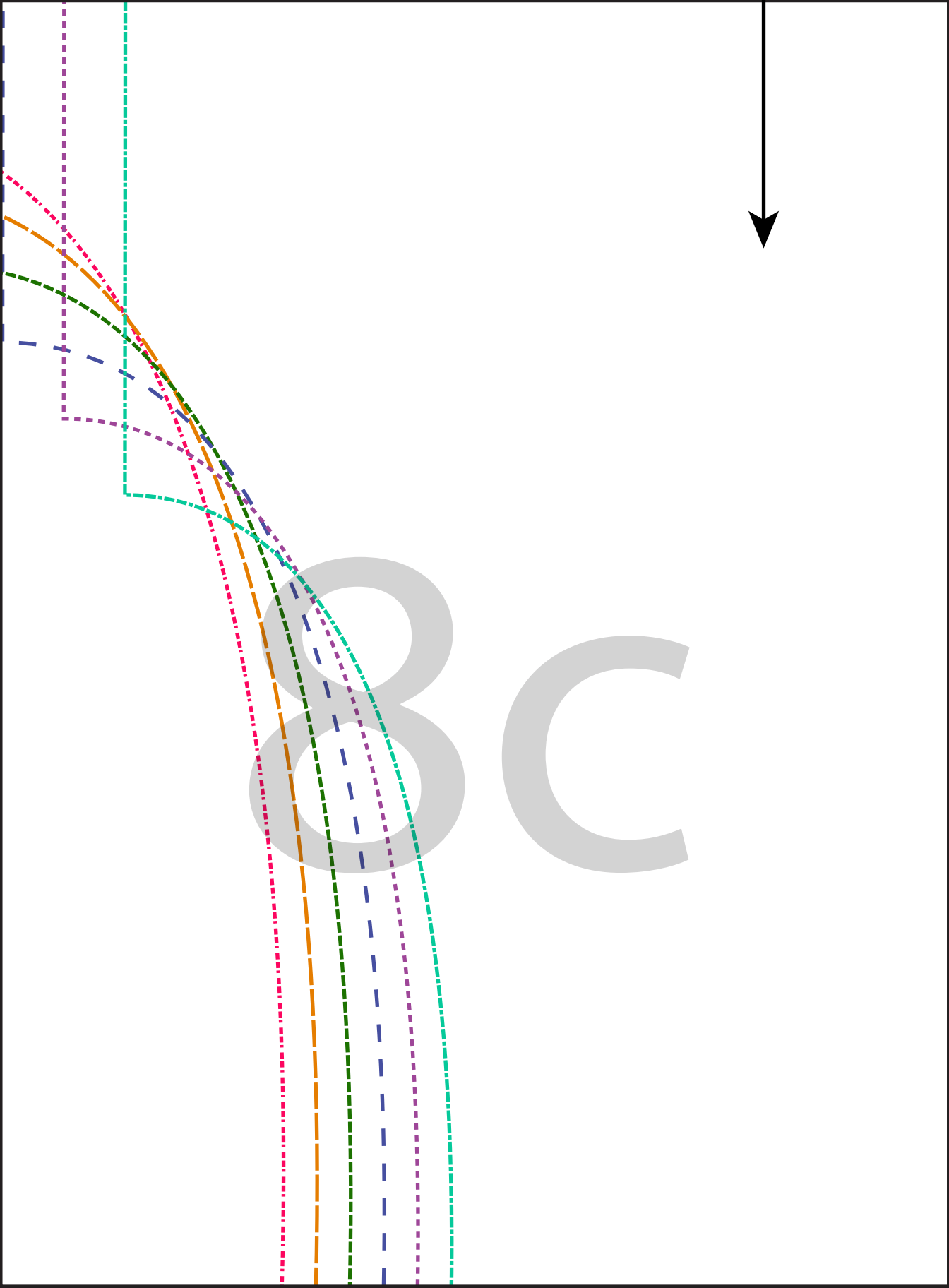

MENS Chore Jacket
Back Lining
Lining Fabric

X2

0

8d

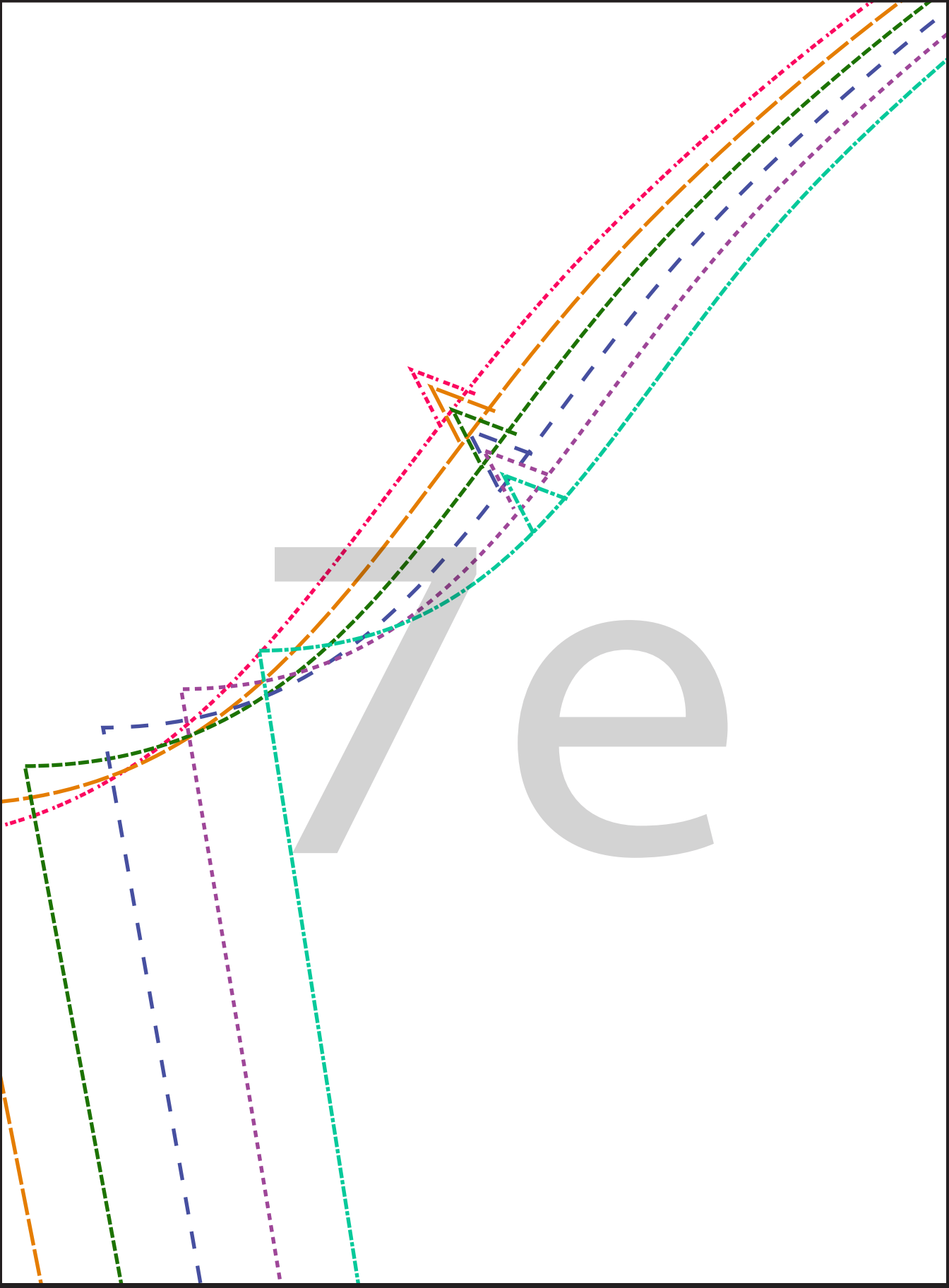

C 7 f



X2

MENS Chore Jacket
Under Sleeve
Self Fabric

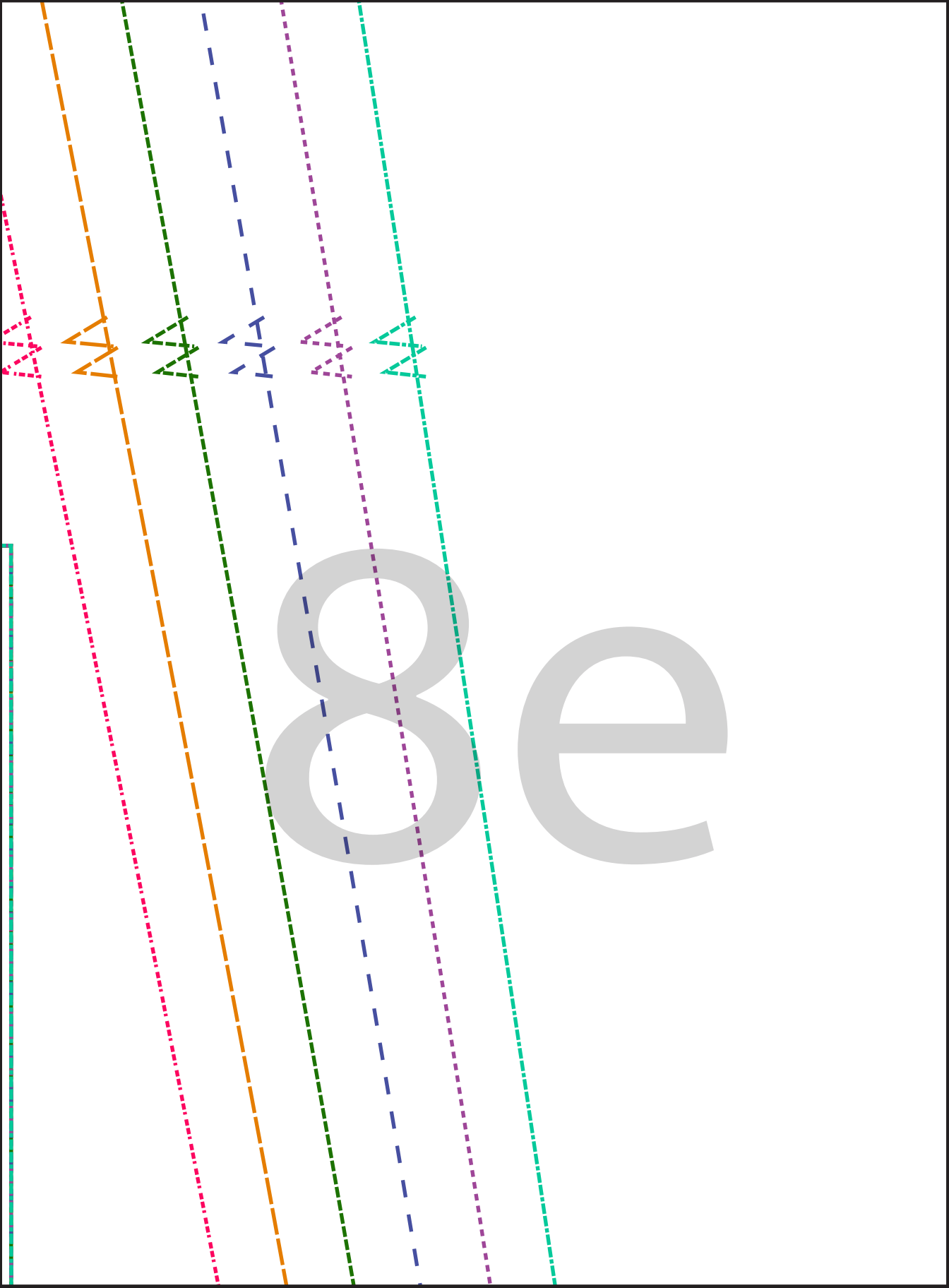



Grainline



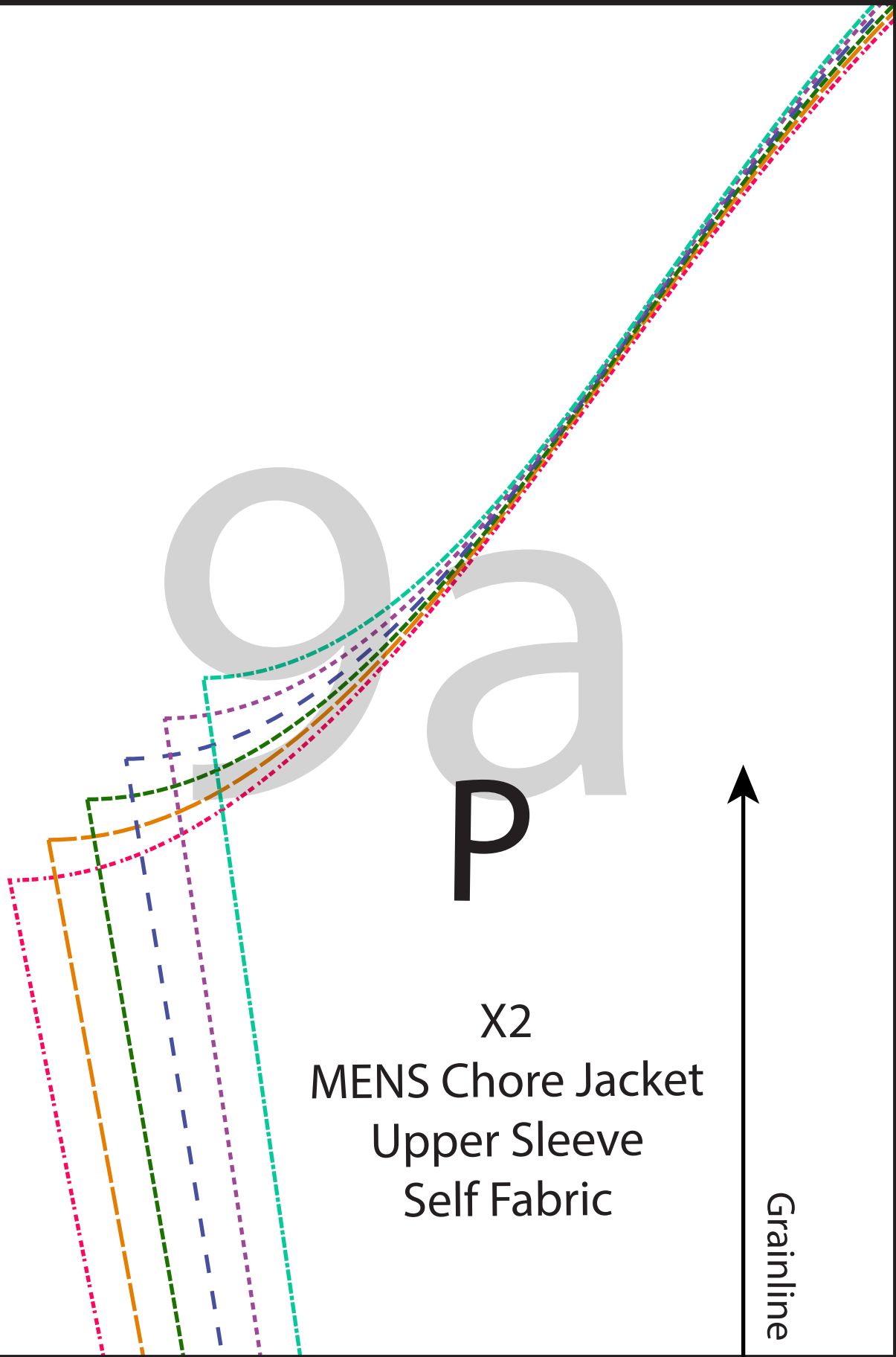

P

X2
MENS Chore Jacket
Upper Sleeve
Self Fabric

Grainline



9b

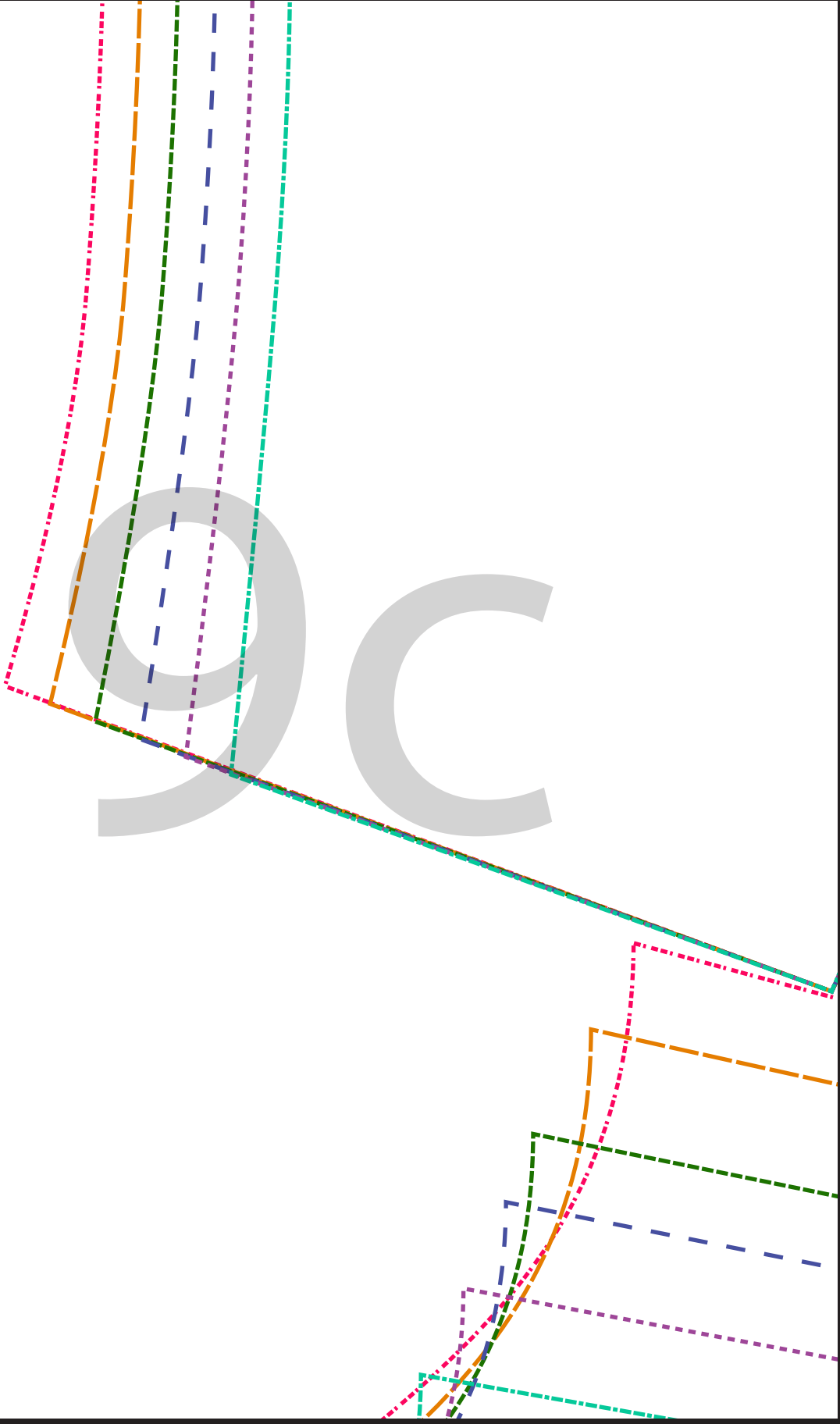

9d

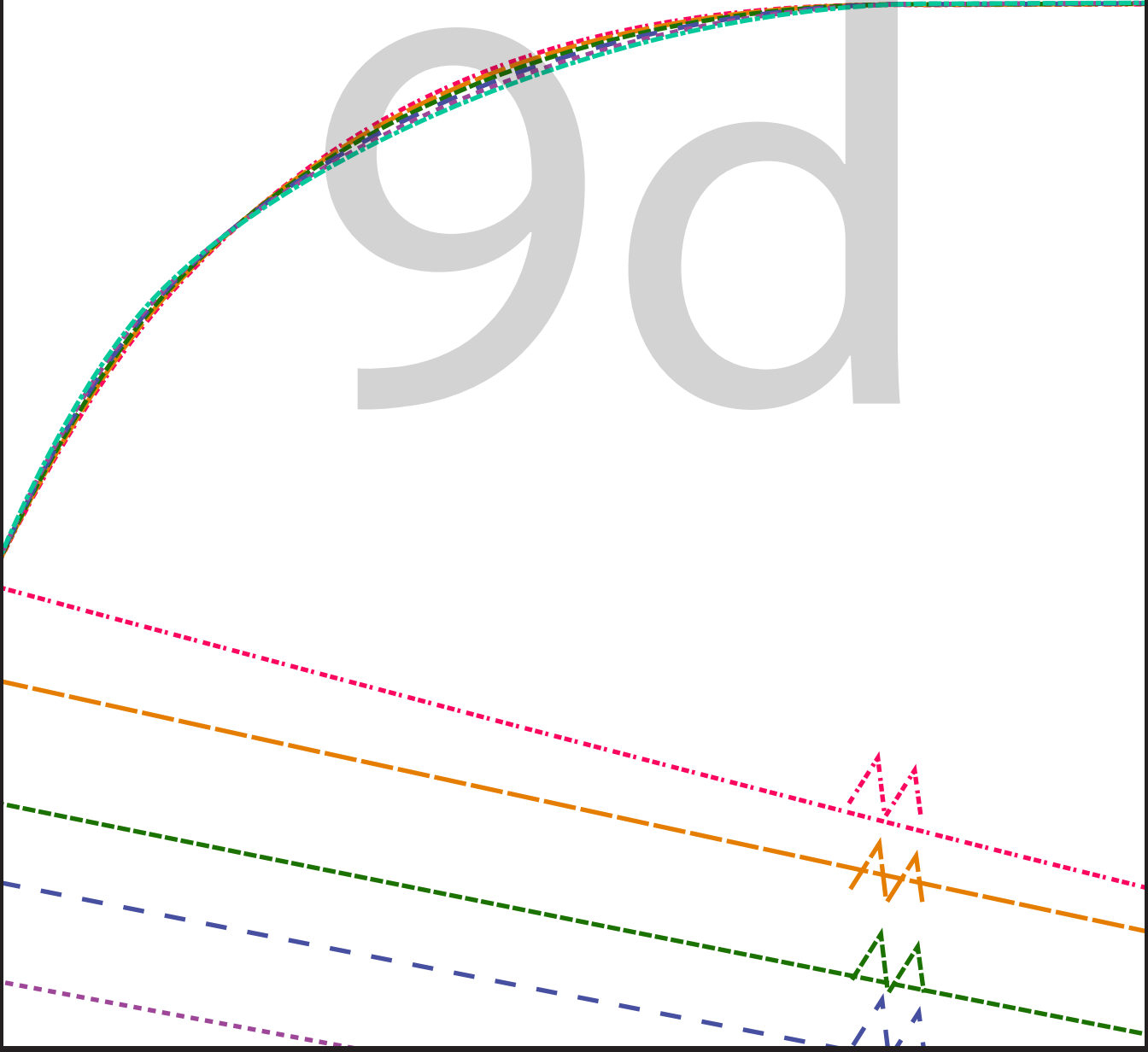

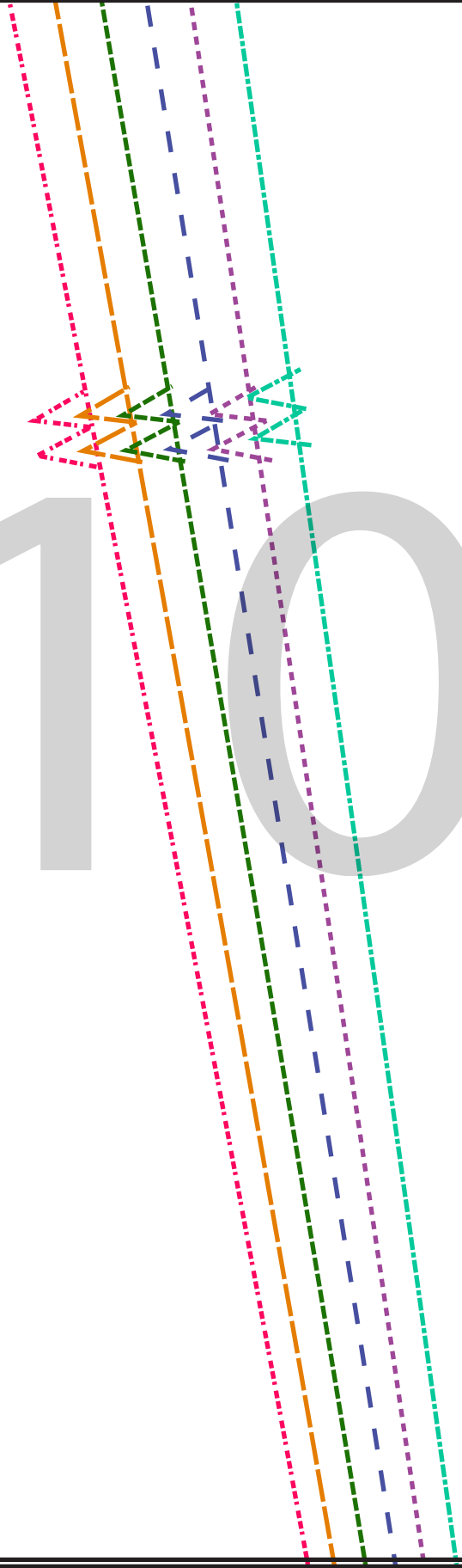

100



CLOTHWORK
collective

KS

10b

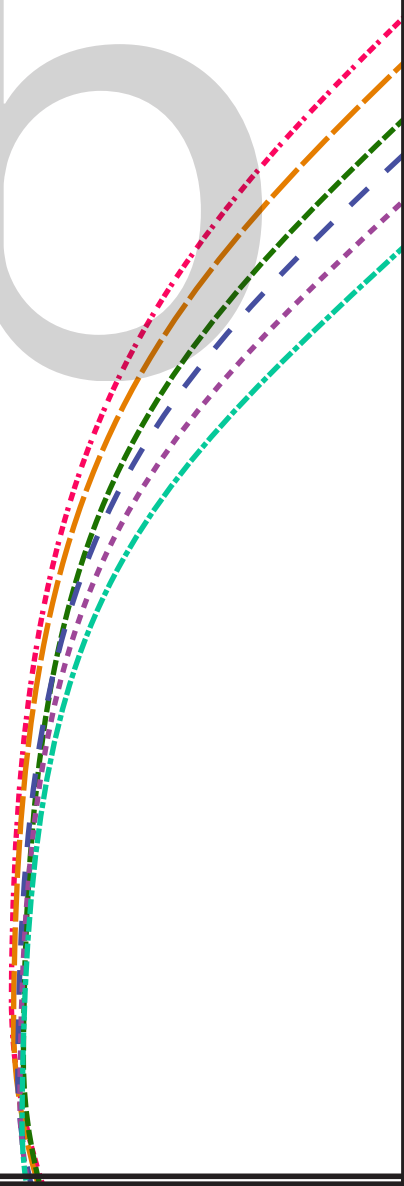

M

X2

MENS Chore Jacket

Sleeve Lining

Lining Fabric

1111

10C

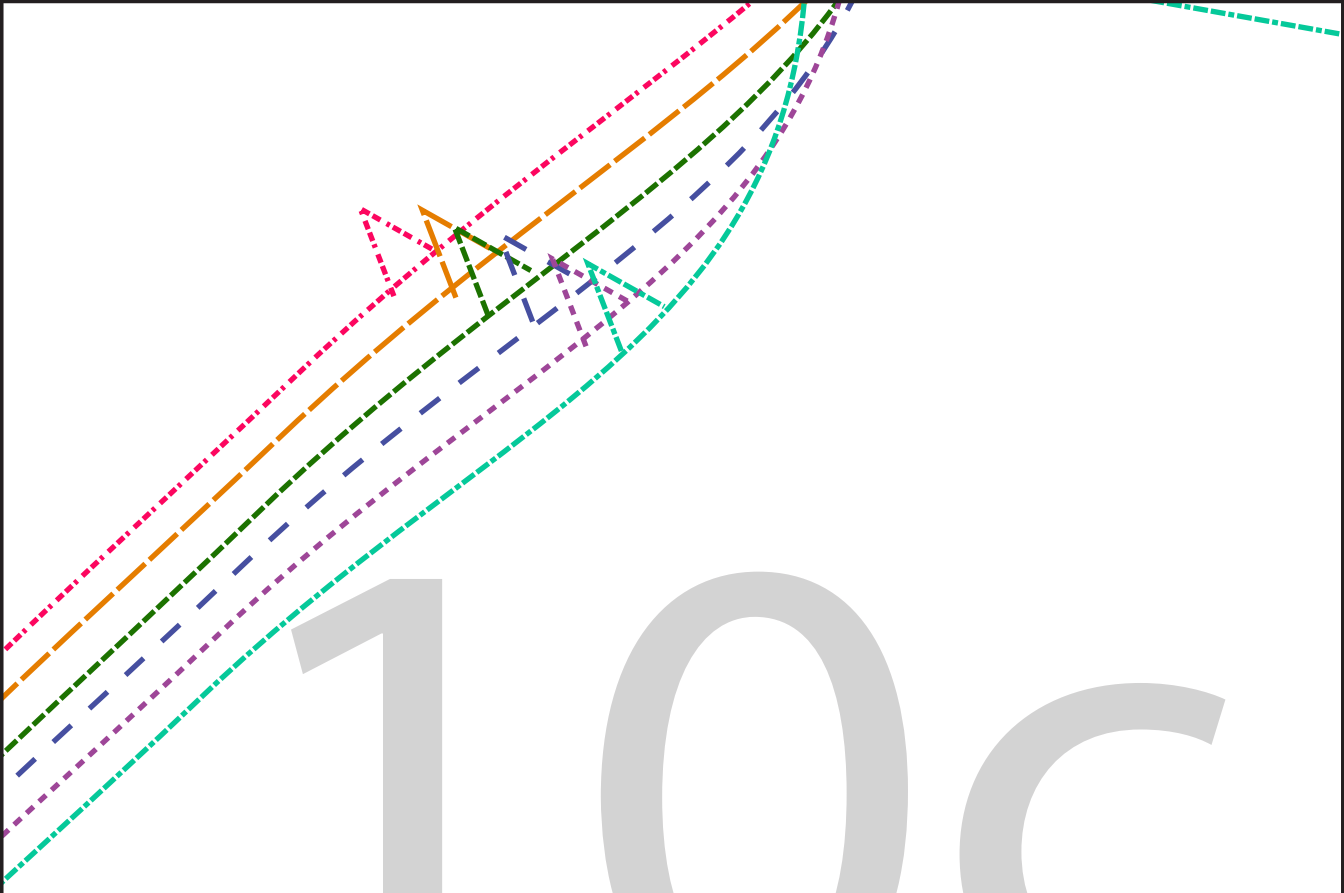

100d

Gr

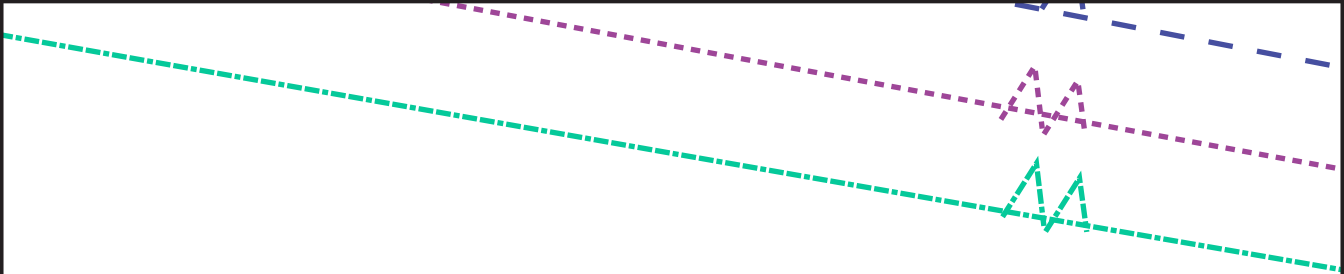

ge

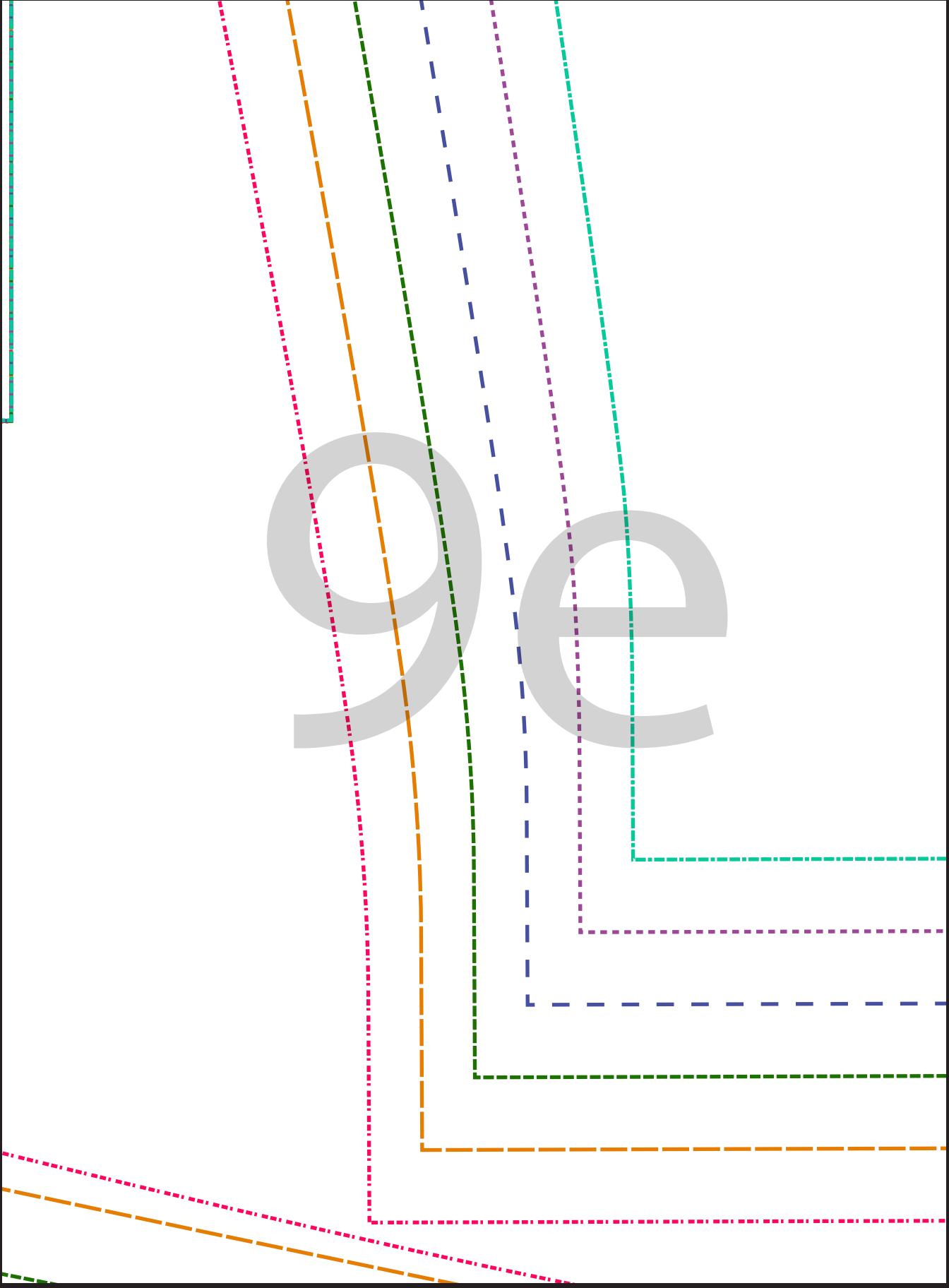

10e



9f



CLOTHWORKS

collective

10f

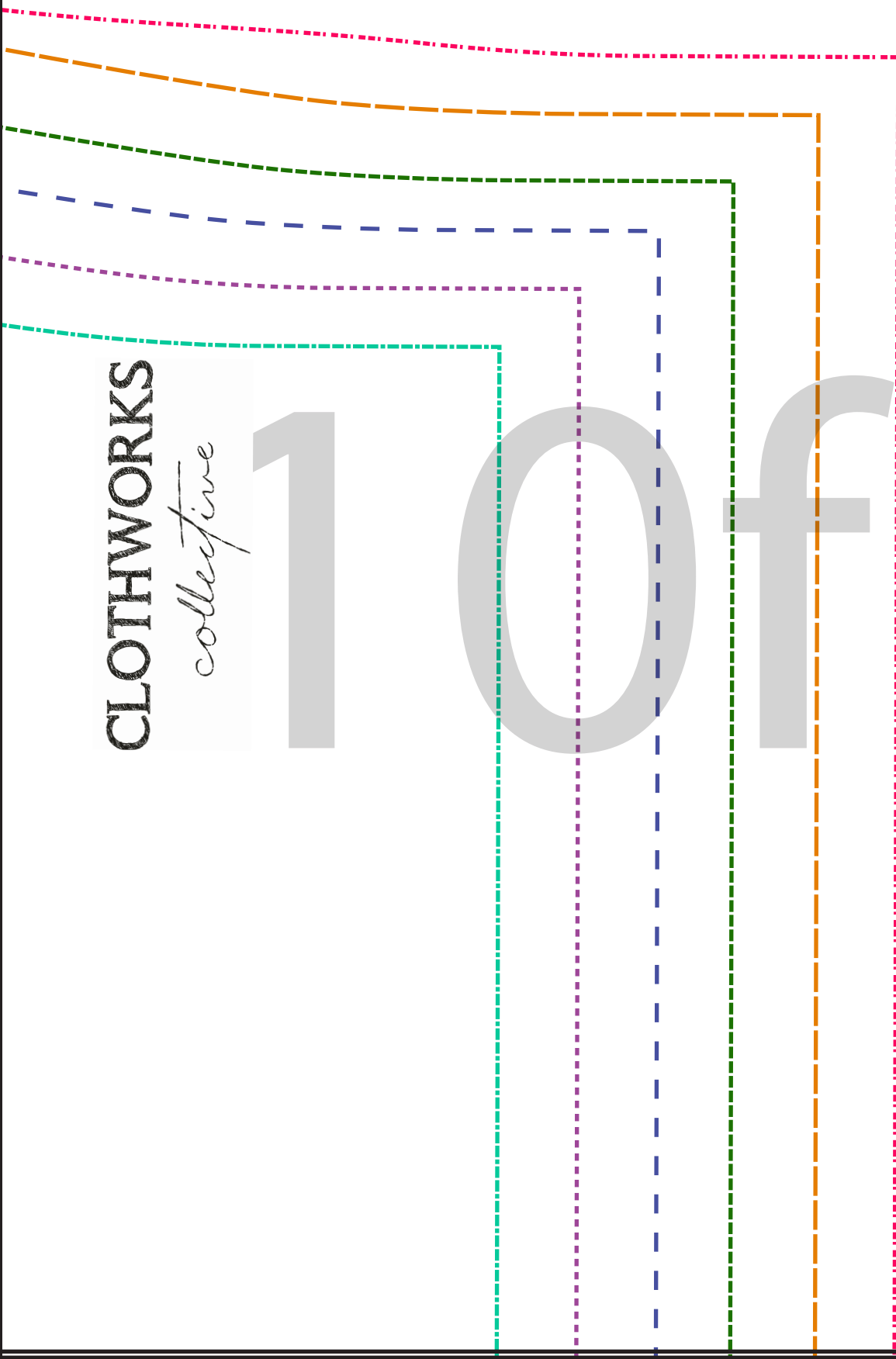

1 1 a

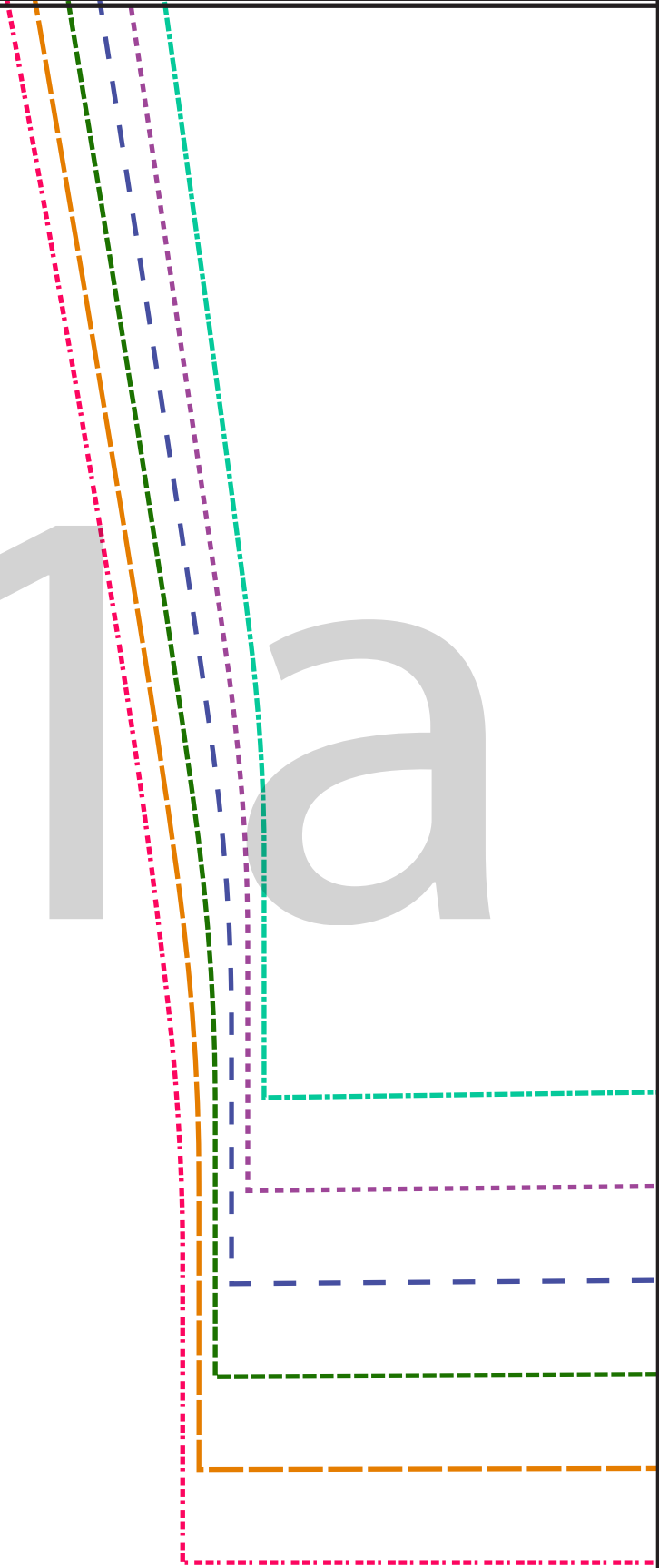

1 1 b

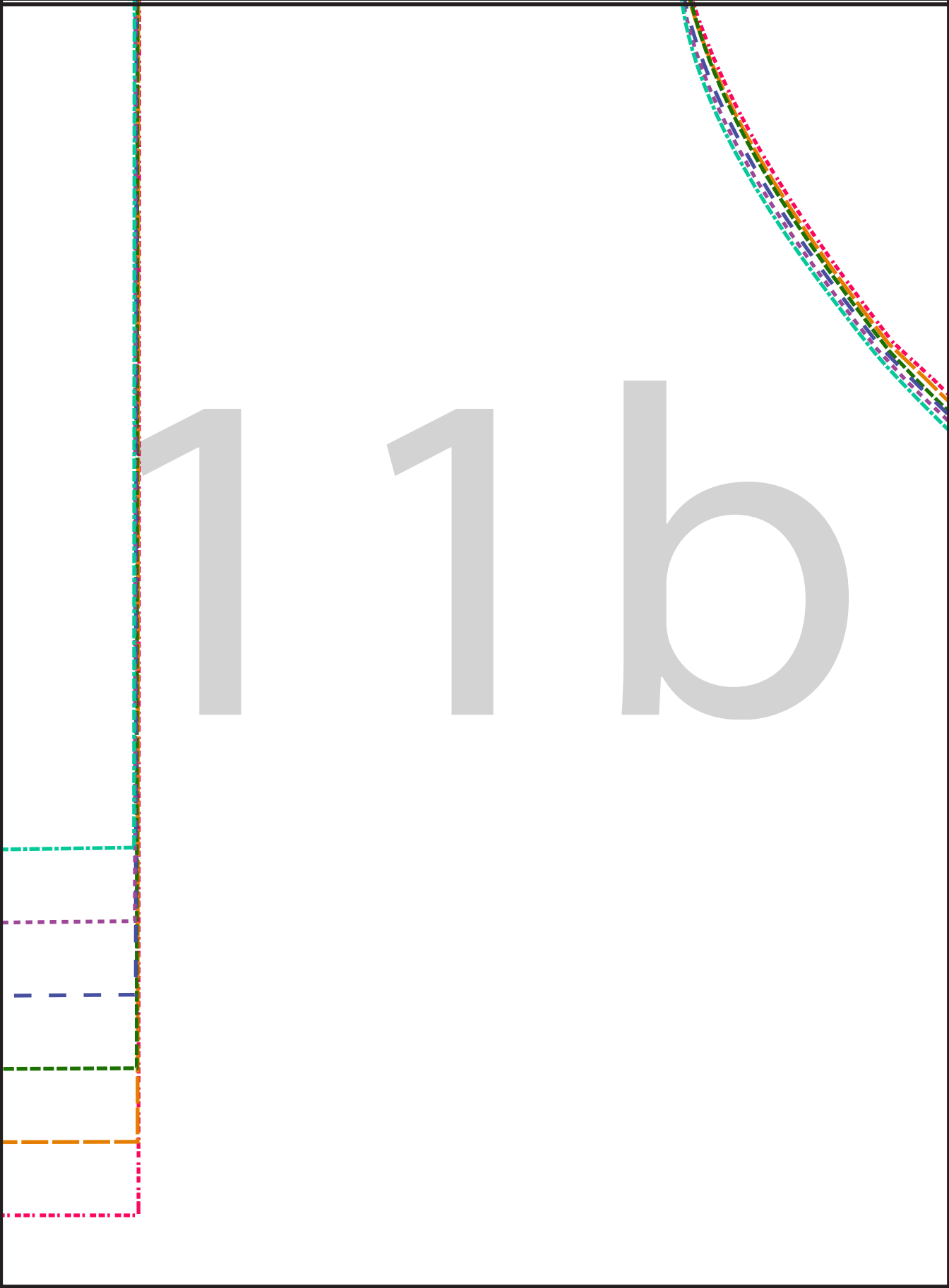

11c

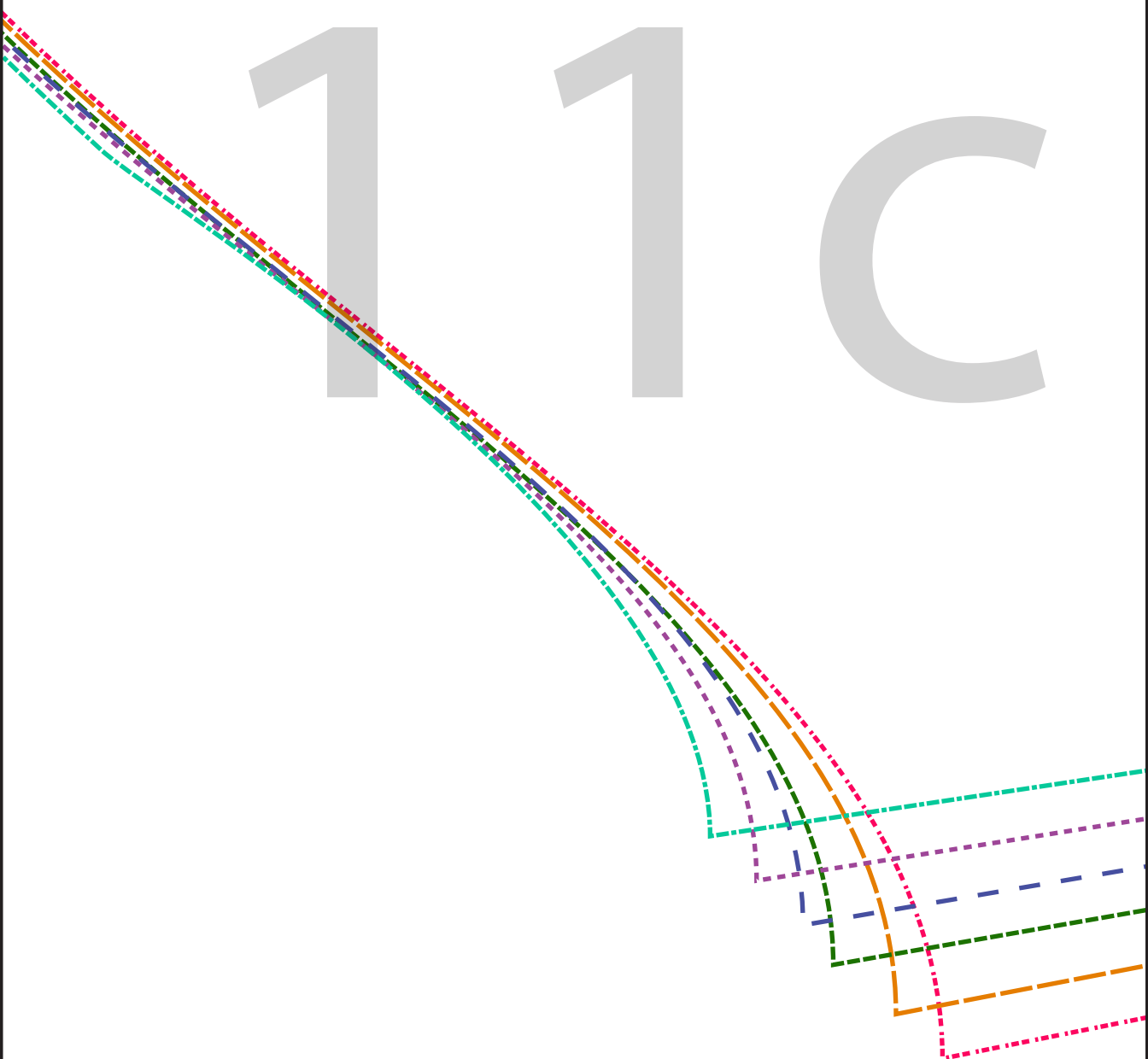

1 1 d

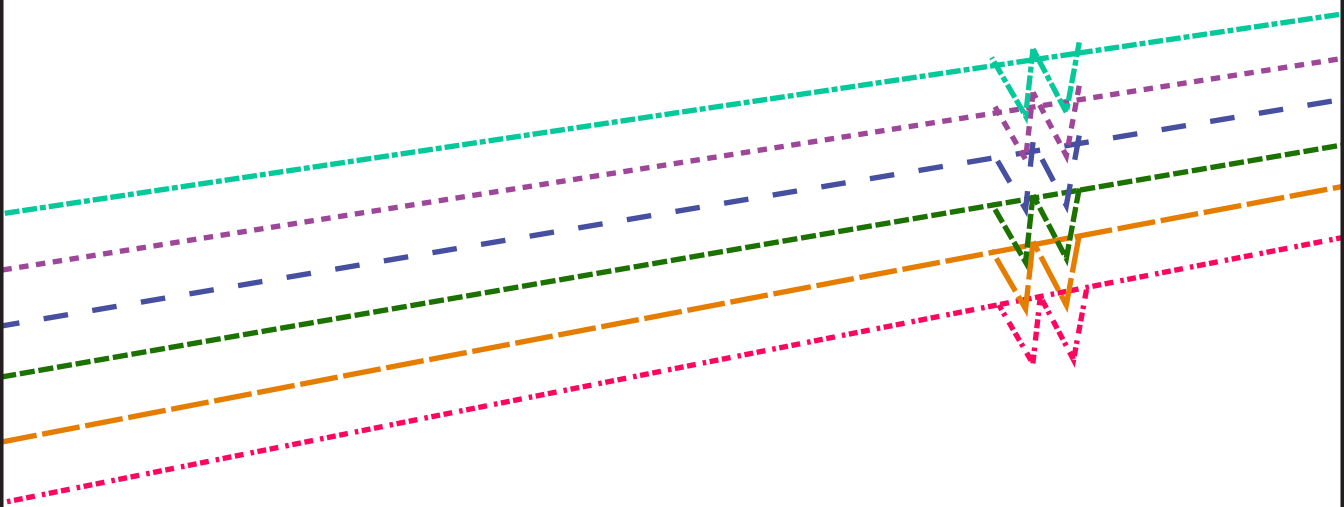

11e

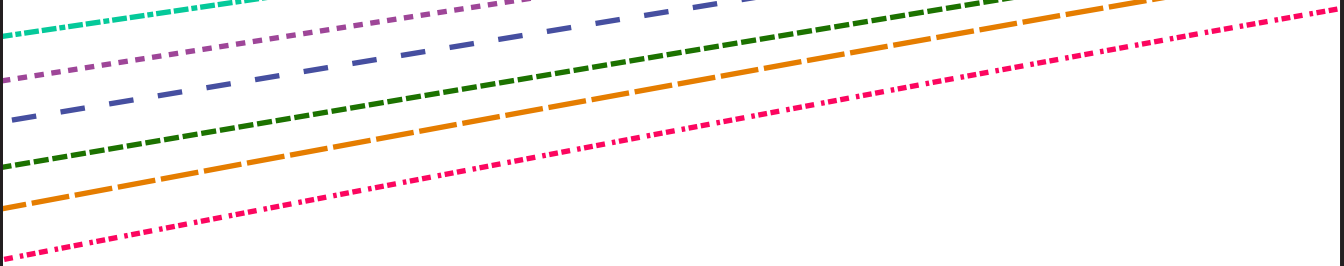
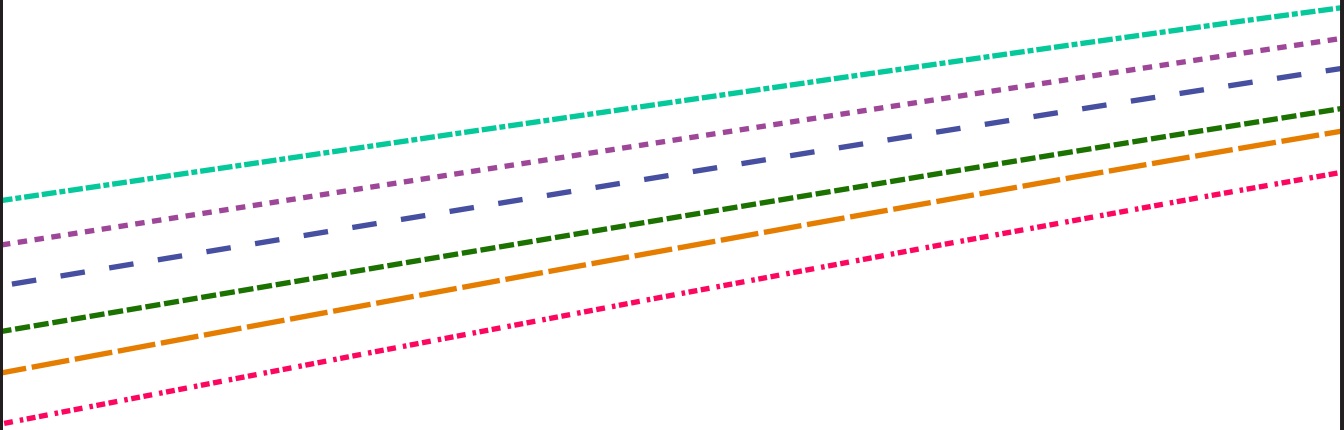

1

1

f

